

DataMan[®] 8050 Reference Manual



2021 February 26
Revision: 6.1.10.25



Legal Notices

The software described in this document is furnished under license, and may be used or copied only in accordance with the terms of such license and with the inclusion of the copyright notice shown on this page. Neither the software, this document, nor any copies thereof may be provided to, or otherwise made available to, anyone other than the licensee. Title to, and ownership of, this software remains with Cognex Corporation or its licensor. Cognex Corporation assumes no responsibility for the use or reliability of its software on equipment that is not supplied by Cognex Corporation. Cognex Corporation makes no warranties, either express or implied, regarding the described software, its merchantability, non-infringement or its fitness for any particular purpose.

The information in this document is subject to change without notice and should not be construed as a commitment by Cognex Corporation. Cognex Corporation is not responsible for any errors that may be present in either this document or the associated software.

Companies, names, and data used in examples herein are fictitious unless otherwise noted. No part of this document may be reproduced or transmitted in any form or by any means, electronic or mechanical, for any purpose, nor transferred to any other media or language without the written permission of Cognex Corporation.

Copyright © 2021. Cognex Corporation. All Rights Reserved.

Portions of the hardware and software provided by Cognex may be covered by one or more U.S. and foreign patents, as well as pending U.S. and foreign patents listed on the Cognex web site at: cognex.com/patents.

The following are registered trademarks of Cognex Corporation:

Cognex, 2DMAX, Advantage, AlignPlus, Assemblyplus, Check it with Checker, Checker, Cognex Vision for Industry, Cognex VSOC, CVL, DataMan, DisplayInspect, DVT, EasyBuilder, Hotbars, IDMax, In-Sight, Laser Killer, MVS-8000, OmniView, PatFind, PatFlex, PatInspect, PatMax, PatQuick, SensorView, SmartView, SmartAdvisor, SmartLearn, UltraLight, Vision Solutions, VisionPro, VisionView

The following are trademarks of Cognex Corporation:

The Cognex logo, 1DMax, 3D-Locate, 3DMax, BGAll, CheckPoint, Cognex VSoC, CVC-1000, FFD, iLearn, In-Sight (design insignia with cross-hairs), In-Sight 2000, InspectEdge, Inspection Designer, MVS, NotchMax, OCRMax, PatMax RedLine, ProofRead, SmartSync, ProfilePlus, SmartDisplay, SmartSystem, SMD4, VisiFlex, Xpand

Portions copyright © Microsoft Corporation. All rights reserved.

Portions copyright © MadCap Software, Inc. All rights reserved.

Other product and company trademarks identified herein are the trademarks of their respective owners.

Table of Contents

Legal Notices	2
Table of Contents	3
Symbols	5
Precautions	6
Getting Started	7
About DataMan 8050	7
DataMan 8050 Accessories	8
Miscellaneous Accessories	8
Cables	10
DataMan 8000 Series Base Station Cables	10
Physical Layout of the Reader	11
Physical Layout of the Base Station	12
Setting up Your DataMan 8050	14
Setting up the Reader	14
Install the DataMan SetupTool and Connect to Reader	14
DataMan 8050 Specifications	14
DataMan 8050 Imager Specifications	16
DataMan DataMan 8050 Base Station Specifications	16
LED Wavelengths for DataMan 8050 Reader	16
Connection Options	17
Connecting a DataMan 8050 Through Ethernet	17
Connecting a DataMan 8050 Through RS-232	18
Connecting a DataMan 8050 through USB	19
Using Your Device Through USB	20
Using DataMan 8050 Wireless Reader	22
Connecting to a Wireless DataMan 8050 Through a Base Station	22
Pairing Wireless Readers to Base Station	24
Pairing Strategy (DMA-IBASE-BT-XX)	25
Unpair Reader From Base Station	26
Base Station Routing Capabilities	26
Ad-hoc Mode	27
Infrastructure Mode	27
Buffering Data	28
Summary of Wireless Buffering Indicators	30
Charging	31
Changing Batteries	33
Reading Codes with the DataMan 8050	36
Industrial Protocols	36
Trigger Types	37
Field of View and Reading Distances	37
Cleaning and Maintenance	39
Cleaning the Reader Housing	39
Cleaning the Reader Lens Cover	39

Compliance Information, Warnings and Notices	40
Regulations and Conformity	40
Compliance Statements: DataMan Base Station	41
For European Community Users	42
中国大陆 RoHS (Information for China RoHS Compliance)	42

Symbols

The following symbols indicate safety precautions and supplemental information:

 **WARNING:** This symbol indicates a hazard that could cause death, serious personal injury or electrical shock.

 **CAUTION:** This symbol indicates a hazard that could result in property damage.

 **Note:** This symbol indicates additional information about a subject.

 **Tip:** This symbol indicates suggestions and shortcuts that might not otherwise be apparent.

Precautions

To reduce the risk of injury or equipment damage, observe the following precautions when you install the Cognex product:

- This product is intended for industrial use in automated manufacturing or similar applications.
- The safety of any system incorporating this product is the responsibility of the assembler of the system.
- This product does not contain user-serviceable parts. Do not make electrical or mechanical modifications to product components. Unauthorized modifications can void your warranty.
- Route cables and wires away from high-current wiring or high-voltage power sources to reduce the risk of damage or malfunction from the following causes: over-voltage, line noise, electrostatic discharge (ESD), power surges, or other irregularities in the power supply.
- Changes or modifications not expressly approved by the party responsible for regulatory compliance could void the user's authority to operate the equipment.
- Ensure that the cable bend radius begins at least six inches from the connector. Cable shielding can be degraded or cables can be damaged or wear out faster if a service loop or bend radius is tighter than 10X the cable diameter.
- This device should be used in accordance with the instructions in this manual.
- All specifications are for reference purposes only and can change without notice.
- This product is intended for industrial use in automated manufacturing or similar applications.
- The safety of any system incorporating this product is the responsibility of the assembler of the system.
- This product does not contain user-serviceable parts. Do not make electrical or mechanical modifications to product components. Unauthorized modifications can void your warranty.

Getting Started

About DataMan 8050



The DataMan 8050 readers offer Industrial Ethernet communication, and advanced technology for reading 1-D and 2-D codes regardless of size, quality, printing method or surface. DataMan 8050 is available with patented 1DMax+ with Hotbars, class-leading 2-D algorithms and future-proof modular communication slide-ins.

The DataMan 8050 readers use bright field illumination and class leading algorithms in three models: 8050, 8050X, and 8050HDX. The DataMan 8050 is designed for high-speed reading of challenging label-based barcodes, the 8050X reads more challenging barcodes, including direct part mark barcodes, while the 8050HDX is a high density reader with a closer field of view.

The DataMan 8050 readers are available with the following communication options:

- USB
- RS-232
- Bluetooth
- Wi-Fi

An intelligent base station is provided when the DataMan 8050 reader uses Bluetooth or Wi-Fi connection. The base station acts as a router between the reader and your computer, PLC, or network. Infrastructure Mode does not use the base station for communication. (See [Infrastructure Mode](#)).







Note: The term 'wireless' refers to the Wi-Fi or to the Bluetooth communication module of the reader.

The DataMan 8000 series base stations are available with the following communication options:

	Base Station Communication			Wireless Protocol	
	Ethernet with Industrial Protocols	USB	RS-232	Bluetooth	WiFi
DMA-CBASE-01		√			
DMA-IBASE-BT-01		√	√	√	
DMA-IBASE-BT-02	√	√	√	√	
DMA-IBASE-01	√	√	√		√

DataMan 8050 Accessories

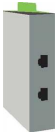



Miscellaneous Accessories

Accessory Name	Accessory Number	Accessory Image
Serial/USB slide-in	DMCM-SERIALM-00	
Ethernet slide-in	DMCM-ENETM-00	
Bluetooth slide-in	DMCM-BTM-00	
Wireless slide-in	DMCM-WLESSM-00	
Charging Base Station	DMA-CBASE-01	
Intelligent Base Station	DMA-IBASE-01	
Intelligent Bluetooth Base Station	DMA-IBASE-BT-01	
Intelligent Bluetooth Base Station	DMA-IBASE-BT-02	
Power Supply for Base Station	DMA-24VPWR-xx ¹	
Power Supply for Reader	DM100-PWR-000	
5000 mAh Battery for the wireless Reader	DMA-HHBATTERY-01	
Multi-Battery Charger	DMA-MBC-xx ²	
POE Adapter	CPS-24V-POE1	
POE Adapter	CPS-24V-POE4	
POE Adapter	CPS-AC-POE1A-xx ³	

¹ xx can be US, EN, UK, or JP.







² xx can be US, EN, UK, or JP.

³ xx can be US, EN, UK, or JP.

Accessory Name	Accessory Number	Accessory Image
Wall Mount	DMA-WALL-8000-00	
Wall Mount for Base Station	DMA-IBASE-WALL-00	
Stand	DM-STAND-00	
Rubber sleeve	DM8050-SLEEVE-00	



Cables

Note: Cables are sold separately.

Accessory Name	Accessory Number	Accessory Image
RS-232 coiled cable for Reader, 2.5 m	DM8000-RS232-02	
RS-232 industrial cable for Reader, 2.5 m	DM8000-RS232IND-02	
RS-232 coiled cable for Reader, 4 m	DM8000-RS232-05	
USB cable, 2.5 m	DM8500-USB-00	
USB coiled cable, 2.5 m	DM8500-USBC-02	
Ethernet coiled cable, 5 m	DM8000-ECABLEC-05 ¹	
Ethernet cable, 2.5 m	DM8000-ECABLE-02	
Ethernet cable, 5 m	DM8000-ECABLE-05	
Ethernet cable, 30 m	DM8000-ECABLE-30	

DataMan 8000 Series Base Station Cables

Note: Cables are sold separately.

Accessory Name	Accessory Number	Illustration
RJ25 (RJ12) to DSUB9 cable for Base Station, 5 m	DMA-RS232RJ-05	
Straight 10ft USB cable	DMA-USB-00	

USB cable for base station: Use any standard USB-A to USB-B 2.0 cable up to 3 meters.

Ethernet cable for base station: Use any standard CAT5/5e, SF/FTP or S/FTP cable.

¹ Collimated cable length including DM8000-ECABLE-X should not exceed 50 m.

Physical Layout of the Reader



DataMan 8050 Reader

1	LED aimer guide
2	Trigger (press and hold to read)
3	Communication module insertion point
4	Lanyard hook
5	Indicator light

Physical Layout of the Base Station

DMA-IBASE-01

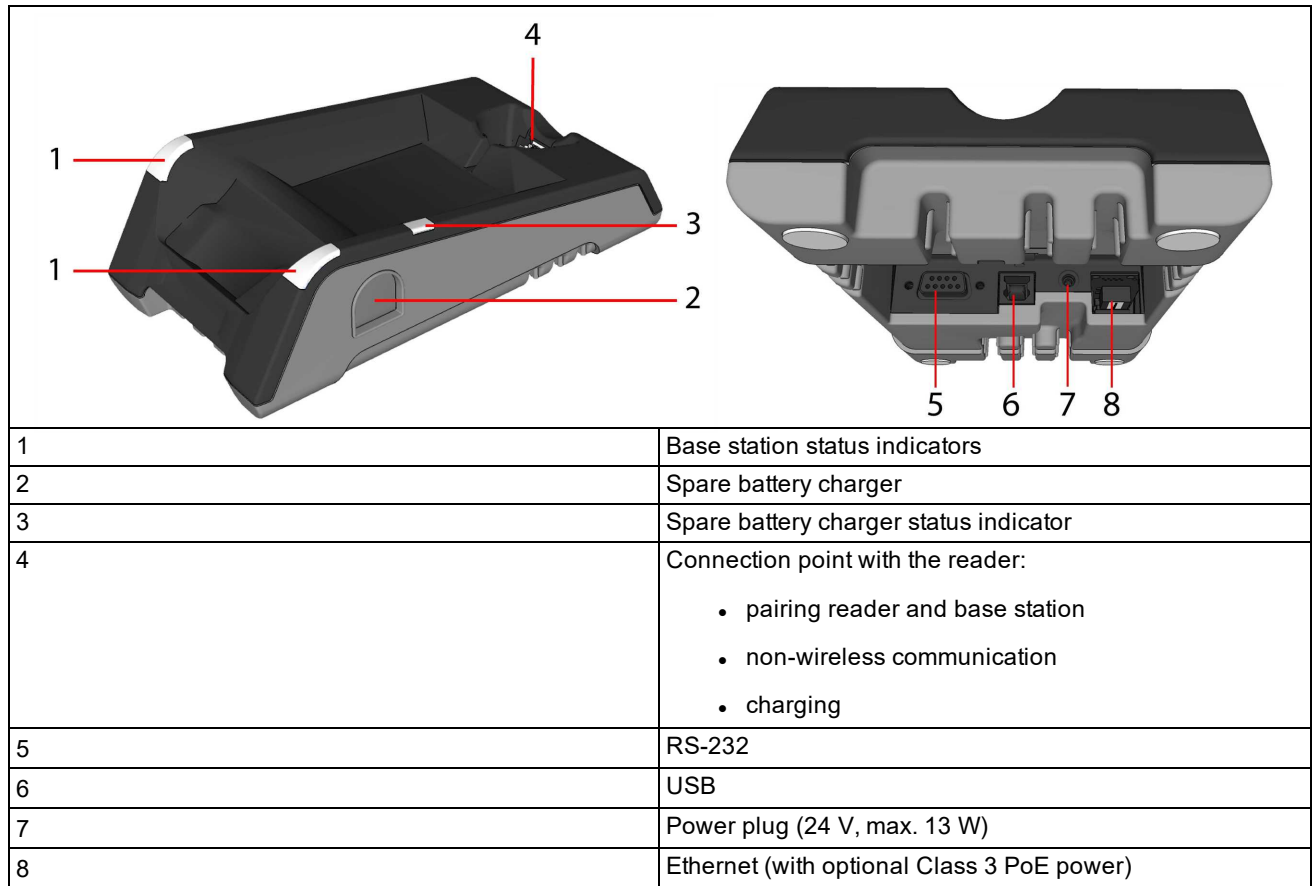

DMA-IBASE-BT-XX

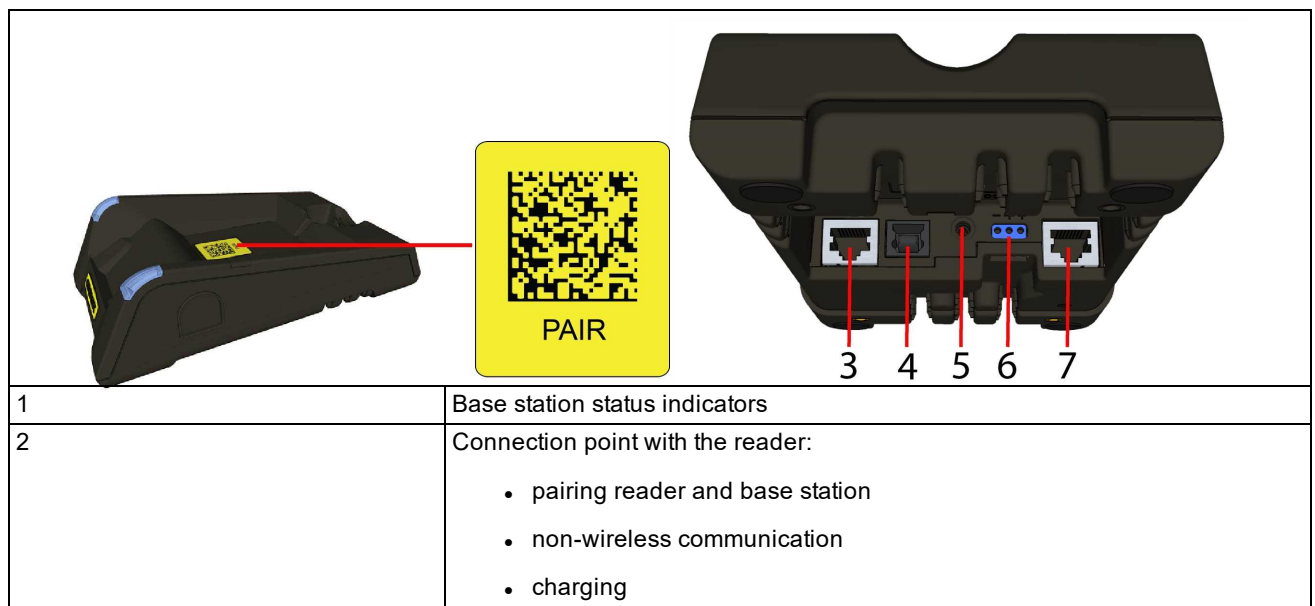

3	RS-232
4	USB
5	Power plug (24 V, max. 15 W)
6	Alternative power supply connector (24 V, max. 15 W, polarity marked on the plastic part near the connector) Recommended wire diameter is 14-18 AWG
7	Ethernet

Base Station status indicators:

- Power: RED = base powered / BLINK = wrong reader in base
- Communication: BLUE = Wireless link / BLINK = Wireless communication
- Cradle connections: GREEN = reader properly inserted / BLINK = cradle USB interface communication

Note:

- DMA-IBASE-BT-01 does not support Ethernet
- DMA-IBASE-BT-02 supports Ethernet

Setting up Your DataMan 8050

Setting up the Reader

To connect to the reader or base station on your computer:

1. Select the connection type: Ethernet, RS-232 Serial, or USB, and connect the cables respectively.



Ethernet



RS-232

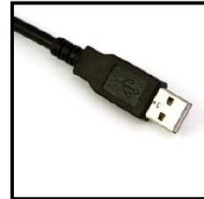

USB

2. Turn on your device(s).

Install the DataMan SetupTool and Connect to Reader

1. Check the DataMan **Release Notes** for a full list of system requirements.
2. Download the DataMan Setup Tool from cognex.com/support/dataman and follow the on-screen steps.
3. Connect the DataMan 8050 to your PC.
4. Launch the DataMan Setup Tool and click **Refresh**. The reader or the base station appears under **COM ports** or **Network devices**.
5. Select a **COM port** or a **Network device** and click **Connect**.



DataMan 8050 Specifications

Specification	DataMan 8050 Reader
Weight	400 g (with battery) Wireless: 530 g (18.70 oz) (battery included)
Operating Temperature	0 °C — 45 °C (32 °F — 113 °F)
Storage Temperature	-10 °C — 60 °C (14 °F — 140 °F)

Specification	DataMan 8050 Reader
Maximum Humidity	< 95% (non-condensing)
Environmental	IP65
ESD Safety (option for DM8050 and DM8050HDX)	The products fulfill the requirements of IEC 61340-5-1
Symbologies	1-D barcodes: Codabar, Code 39, Code 128, and Code 93, Interleaved 2 of 5, Pharma, GS1 DataBar, Postal, UPC/EAN/JAN, DataBar 2-D barcodes: Data Matrix™, QR Code and microQR Code, RSS/CS, PDF 417, MicroPDF 417
Power Supply Requirements	USB: bus powered (optionally: external 2.5 W max LPS or NEC class 2 power supply +5 V - +6 V DC) RS232: external 2.5 W max LPS or NEC class 2 power supply +6 V 1 A DC ETH: Class 2 PoE supply IEEE 802.3af (connect only to PoE networks without routing to the outside plant)
Inrush current peak	5A maximum Duration: approx. 30 μ s Electrical charge: 60 μ As at 6 V Maximum capacity: 10 μ F Maximum inrush: 50 μ C
Battery life for wireless reader (typical use case)	ca. 3200 triggers can be operated within a 10 hour working shift The expected life time of the battery is 5 years.
Ethernet	10/100 Base-T FULL/HALF DUPLEX, IEEE 802.3
Bluetooth	Bluetooth™ 2.1, 2.4 GHz
Wi-Fi	802.11 b/g, 2.4 GHz, User Selectable channels 1-11
Protection	

DataMan 8050 Imager Specifications

Specifications	DataMan 8050 Imager
Image Sensor	1/3 inch CMOS
Image Sensor Properties	6.0 μm square pixels
Image Resolution	752 x 480 pixels
Lens Type	6.2 mm F:10 lens with IR blocking filter

DataMan DataMan 8050 Base Station Specifications

Specification	DMA-IBASE-BT-XX	DMA-IBASE-01
Weight		328 g
Operating Temperature	0 °C — 45 °C (32 °F — 113 °F)	0 °C — 40 °C (32 °F — 104 °F)
Storage Temperature	-40 °C — 60 °C (-40 °F — 140 °F)	-40 °C — 60 °C (-40 °F — 140 °F)
Maximum Humidity	95% (non-condensing)	95% (non-condensing)
Power Supply Requirements	5.5 V DC, 6 W maximum LPS or NEC Class 2 power supply or PoE Class 2 power supply	24 V +/- 10%, 13 W maximum LPS or NEC class 2 power supply, or PoE class 3 (connect only to PoE networks without routing to the outside plant)
Protection	IP65	

LED Wavelengths for DataMan 8050 Reader

Note: The data below refer to the LED Illumination accessory of the reader, not to the LED indicators.

The following table shows LED types and the related wavelengths:

LED	λ [nm]
RED	660

Connection Options

Connecting a DataMan 8050 Through Ethernet

1. Connect the Ethernet slide-in (DMCM-ENETM-00) to your DataMan 8050.



2. With a 2.5 mm Allen wrench, tighten the screws so that the slide-in is firmly locked.

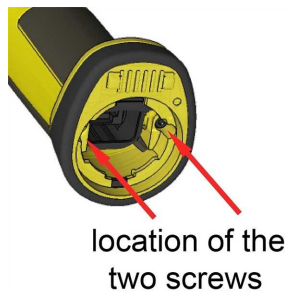

3. Insert the plug. Slide the cable lock up to the reader, and twist the cable lock in place.



Use the DM8000-ECABLE-05 (5 meters) or the DM8000-ECABLE-30 (30 meters). You also need a Power Over Ethernet Adapter (CPS-AC-POE1A-xx).

Note: Disconnect the DataMan 8050 reader from power before inserting/removing communication modules.

Connecting a DataMan 8050 Through RS-232

1. Connect the serial slide-in (DMCM-SERIALM-00) to your DataMan 8050.



2. With a 2.5 mm Allen wrench, tighten the screws so that the slide-in is firmly locked.

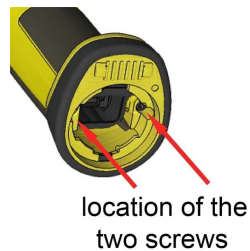

3. Insert the plug. Slide the cable lock up to the reader and twist the cable lock in place.



Use the DM8000-RS232-02 cable (2.5 meters) or the DM8000-RS232-05 cable (5 meters). For power supply, use the DataMan 8000 Power Supply (DM100-PWR-000).

Note: Disconnect the DataMan 8050 reader from power before inserting/removing the communication modules.

Observe the following electrical requirements:

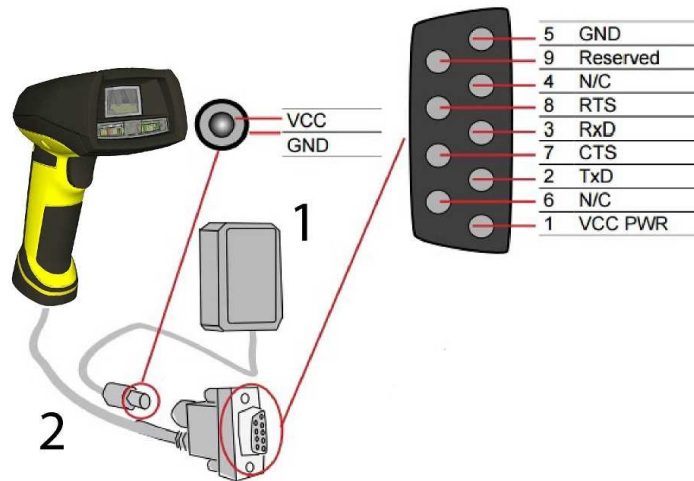

1	6 VDC power supply (DM100-PWR-000), a 5.5 mm x 2.1 mm DC Power Plug
2	VCC = +4.75 V up to +6.0 V for 2.5 m cable VCC = +5.5 V up to +6.0 V for 5.0 m cable

WARNING: For proper RS-232 operation, do not apply any voltage to pin 9.

Note: Power on the RS-232 cable can be supplied by either the DC Power Plug or Pin 1 of the D-SUB. **DO NOT** use both in parallel.

Connecting a DataMan 8050 through USB

1. Connect the serial slide-in (DMCM-SERIALM-00) to your DataMan 8050.



2. With a 2.5 mm Allen wrench, tighten the screws so that the slide-in is firmly locked.

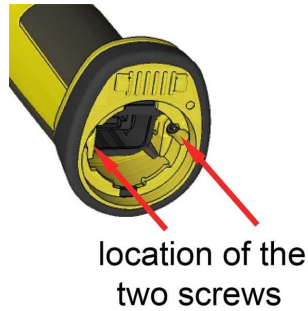

3. Insert the plug, slide the cable lock up to the reader and twist the cable lock in place.



Use the DM8500-USB-00 cable (2.5 meters) or the DM8500-USBC-02 cable (2.5 meters).

Note: DataMan 8050 does not require an external power supply when using USB 3.0.

Note: Disconnect the DataMan 8050 reader from power before inserting/removing the communication modules.

Using Your Device Through USB

If you connect your reader with the coiled USB cable, you must use your device in USB 1.1 mode. With a straight USB cable, you can use your device in both, USB 1.1 and USB 2.0 modes.

Set the **USB Connection** properties in the **Serial** tab of the **Communication Settings** pane in DataMan Setup Tool, or scan the appropriate code from the **DataMan Configuration Codes** document.

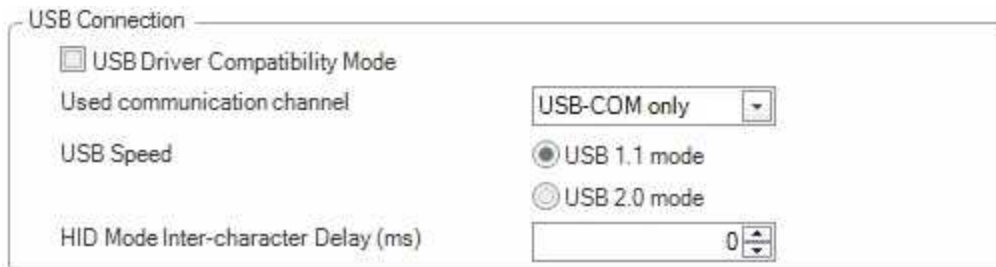

It is also possible to switch the reader and the base station to USB mode (CDC or HID) with a pair of reader configuration codes in the **DataMan Configuration Codes** document.

In the case of a corded reader:



1. Disconnect from the DataMan Setup Tool, if you are connected.
2. Scan the “**USB Keyboard**” code from the *DataMan Configuration Codes* document.
3. Start scanning codes with your corded reader.

In the case of a wireless device:



1. Disconnect from the DataMan Setup Tool, if connected.
2. Scan the “**Enable USB Keyboard for the base station**” code from the *DataMan Configuration Codes* document.
3. Start scanning codes with the wireless reader.

Using DataMan 8050 Wireless Reader

This section provides wireless reader specific procedures.

Connecting to a Wireless DataMan 8050 Through a Base Station

1. Connect the wireless slide-in (DMCM-BTM-00) to your DataMan 8050.

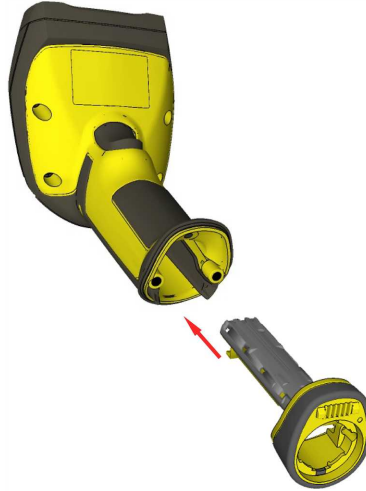

2. With a 2.5 mm Allen wrench, tighten the screws so that the slide-in is firmly locked.

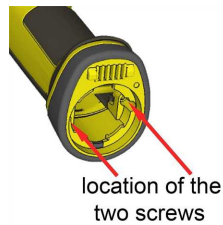

3. Insert the battery.

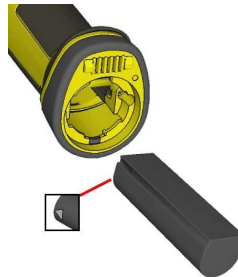

Note: Remove the battery from your DataMan 8050 before inserting/removing the communication module.

4. Insert the plug and twist it in place.



5. Power up the DMA-IBASE-BT-XX base station using a 24V power supply (DMA-24VPWR-XX). In the case of a DMA-IBASE-01 base station, use either a 24V power supply, or a Class 3 Power Over Ethernet adapter.

6. Connect your base station to your PC using either serial, USB or Ethernet communication.

DMA-IBASE-BT-XX		DMA-IBASE-01	
1	RS-232 connection	1	Power
2	USB connection	2	Alternative power supply connector
3	Power	3	Ethernet connection
4	Alternative power supply connector	4	
5	Ethernet connection	5	

Observe the following electrical requirements when connecting the base station through RS-232:

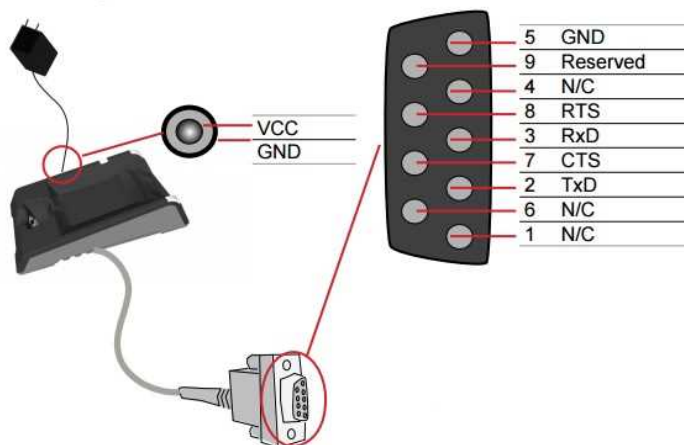

WARNING: For proper RS-232 operation, do not apply any voltage to pin 9.

Power to the base station can be supplied by either the DC power plug or by wiring in 24V. **DO NOT** use both in parallel. The DC power plug is a 24VDC power supply (DMA-24VPWR-xx), 3.5 mm x 1.3 mm.

Note: Be careful to use the appropriate connector for RS-232. See [Step 6](#) above.

- When the base station is powered up, scan the **Pair** scan code and place your reader into the base station. The base station's status indicator becomes GREEN. When the wireless reader is removed from the base, a wireless connection is established. The status indicator of both the base station and the reader become BLUE and you can hear a beep. BLUE lights indicate that the reader and the base have successfully paired and are communicating.
- Connect to your base station or to the wireless reader. You have the following connection options:

Base Station Connection Type	Connect to Reader in the DataMan Setup Tool	Connection Channels
RS-232	Wireless reader appears: COM port (Base Station does not appear)	terminal program Setup Tool
USB	Base Station appears: COM port 1 Wireless reader appears: COM port 2	terminal program Setup Tool
Ethernet	Base station appears: Network device 1 Wireless reader appears: Network device 2	terminal program Setup Tool

- Lift your reader up from the base station and start reading codes.

Note:

- When the reader is on the base station, communication is established by means of cradle contacts. Wireless communication is disabled.
- Configure wireless communication settings by connecting to the base station. In order for the changed settings to be synchronized between the DataMan 8050 wireless reader and the base station, place your reader in the base station after your changes are saved. To assign a static IP address to the base station or the reader when communicating via Ethernet, connect to the base station in the DataMan Setup Tool. The base station, however, auto-assigns the IP address to the reader when they become paired.
- When you connect with the base station to a terminal program, your wireless reader sends decode results to the terminal, but you cannot send commands to the reader.
- To unpair your reader from the base station, either click **Unassign** in the Bluetooth or Wireless tab of the *Communication Settings* pane of the DataMan Setup Tool (when you are connected either with the reader or the base station), or scan the "Unassign Reader" reader configuration code.
- If you place the wrong reader (that is, a reader that is not associated with the base station) into the base station, the base station status indicator flashes red and a series of short beeps can be heard.

Pairing Wireless Readers to Base Station

Pairing Wireless Readers to Base Station Through Bluetooth

To pair with 3rd party devices:

- Start discovery on the 3rd party device.
- Put reader into discovery mode by reading the appropriate configuration code or by using the on-screen menu of the reader.
- Start pairing on the 3rd party device.

4. The following pairing scenarios are available:

- a. For legacy pairing, a PIN is displayed on the reader screen. Enter the PIN into the 3rd party device.
- b. For Secure Connections, a number is displayed on the screen of the reader and on the 3rd party device. Verify if the reader and the 3rd party device match and confirm by pressing the button.
- c. JustWorks: No user action is required.

Note: A non-paired reader is automatically set into discovery mode.

Pairing Strategy (DMA-IBASE-BT-XX)

To pair the base station and the reader in a single step without considering former pairing states and using the DataMan Setup Tool, scan the Pair sticker from the scan code sticker on the base station. Place the reader in the base station.

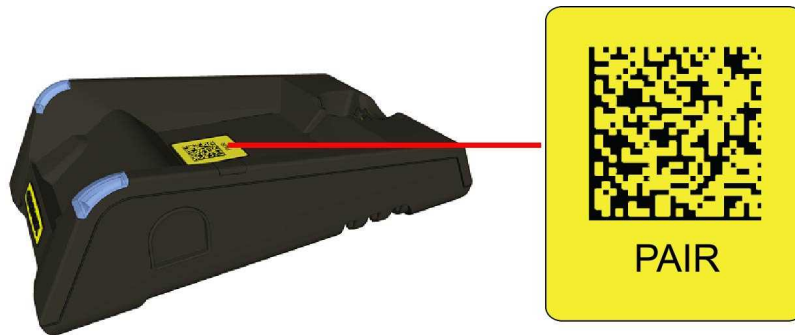

The reader then blinks GREEN/BLUE until it gets paired with the base station (or until the end of the 20 second timeout period). When placing the reader on the base station, the base station drops its pairing with its old reader and pairs with the new reader.

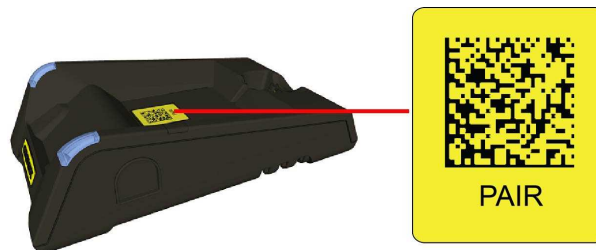

Note: Scanning the Pair code puts the base station and the reader into **force pairing mode**. This means that the reader and the base it is put on get paired regardless of any assignments they both had previously. This force pairing mode is valid for 20 seconds after reading the Pair code.

The indicators of the base station turn GREEN to signal successful pairing:



When the reader is put onto another (unpaired) base station without any previous actions, the base station signals this event by beeping and indicators flashing RED :



The base station that is paired with a certain reader signals a bad reader alert (beeping and indicators flashing RED) also when another, unassigned reader is put into it.

Unpair Reader From Base Station

To unpair the reader from the base station, do either of the following:

- Click **Unassign** in the Bluetooth or Wireless tab of the *Communication Settings* pane of the DataMan Setup Tool (when you are connected either with the reader or the base station).
- Scan the “Unassign Reader” reader configuration code, see the **DataMan Configuration Codes** document.

Base Station Routing Capabilities

The base station is visible as connected through either RS-232, USB, or Ethernet.

The base station transfers data to the reader:

- through the wireless interface, or
- through the cradle USB, when the reader is placed on the base station.

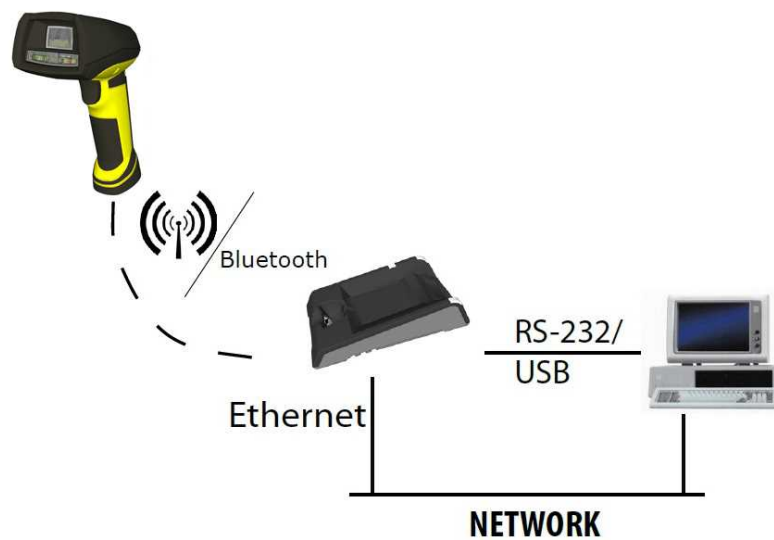

Ad-hoc Mode

Wireless connection to the reader is possible with the computer in ad-hoc mode using a reader-created Wi-Fi connection. Reset the reader to factory defaults (this configures the device to ad-hoc mode), and after the device appears under WiFi connections, connect to it with the DataMan Setup Tool. Click on the **Wireless** tab under **Communication Settings** to configure authentication and encryption (which are not configured by default). For more information, see the *DataMan Communications and Programming Guide*.

Note: The base station is only used for charging the reader in this setup. If an intelligent base station is used, the reader must be unassigned in the DataMan Setup Tool (connected to the base station) under the **Communication Settings > Wireless** tab if the reader has already been placed in the base station.

Note: Placing the reader in the intelligent base station automatically reassigns it to the base station unless the base station is unplugged from the network first.

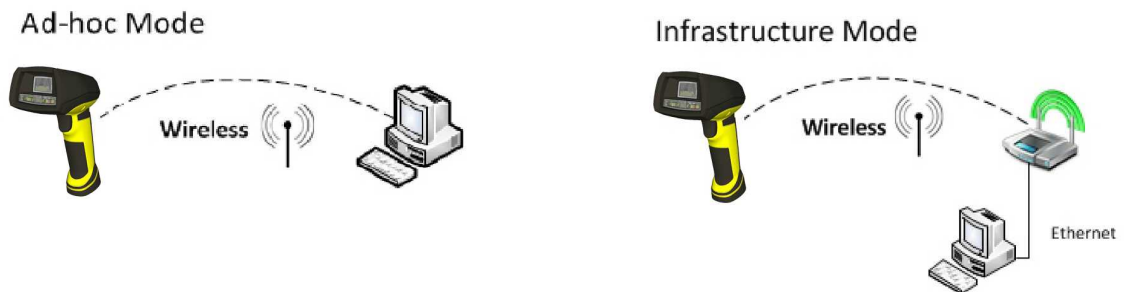

Infrastructure Mode

It is possible to connect to the reader in infrastructure mode using Wi-Fi connection. You need to reset the reader to factory defaults, connect to the reader in ad-hoc mode, and then use the **Wireless** tab under **Communication Settings** to activate and configure infrastructure mode.

Infrastructure mode requires a router as an access point. See the *DataMan Communications and Programming Guide* for detailed information.

Authentication mode	Encryption	Requirements
Open System	WEP-40, WEP-104	passphrase
WPA-PSK, WPA2-PSK	TKIP, AES, TKIP/AES	passphrase
EAP-TLS	TKIP, AES, TKIP/AES	- Client's certificate - CA's certificate - Client's private key - Client's username
PEAP-MSCHAPV2	TKIP, AES, TKIP/AES	- Client's certificate - CA's certificate - Client's username

See the *DataMan Communications and Programming Guide* for detailed information.

Note:



- The base station is only used for charging the reader in this setup. If an intelligent base station is used, the reader must be unassigned in the DataMan Setup Tool (connected to the base station) under the **Communication Settings > Wireless** tab if the reader has already been placed in the base station.
- Placing the reader in the intelligent base station automatically reassigns it to the base station unless the base station is unplugged from the network first.

Buffering Data

When you are within the wireless range of the base station, your wireless reader sends decoded data to your host through the base station, just as if you used a corded reader. You can also see the decoded images in the DataMan Setup Tool, if it is running and is connected to the reader.

When you leave the wireless range, you will lose connection to your PC, but you can still keep reading codes. The decoded data is saved in the buffer of the reader.



Note: The images acquired by the reader when it is out of the wireless range are never saved, and cannot be retrieved.

If you were connected to a terminal program when you left the wireless range, the buffered data appears on your PC again when you come back within the wireless range.

Buffered read results on the reader are not displayed in the DataMan Setup Tool; they are only transmitted over an existing keyboard emulation, RS-232 Serial or TCP/IP Telnet connection.

Open a connection with the reader in a terminal program so that you gain the buffered data when wireless connection is re-established.

Connection options according to communication type:

Base Station Connection Type	How to Connect
RS-232	Connect to the COM port of the base station.
USB	Connect to the COM port of the wireless reader
Ethernet	Connect to the terminal program using the IP address of the reader. To find out the IP address, go to the Connect backstage page in the DataMan Setup Tool and check the IP address of the reader in the Address column.
USB Keyboard	Open the text editor or your program of choice to use keyboard emulation. When you return to the wireless range, keyboard emulation continues, starting with the buffered data.

While you are still within the wireless range, the reader periodically blinks BLUE to indicate that the wireless connection is established.

When the reader leaves the wireless range, the signal of the base station changes to RED.



Blinking BLUE status indicator: wireless connection is alive.



When you leave the wireless range, a long beep and blinking MAGENTA on the indicator signals that the reader is going offline. The status indicator blinks MAGENTA: your reader is offline.



When the reader is offline, good reads are indicated with 2 short beeps and the selected good read status indicator color (GREEN by default). The status indicator beeps twice: your reader is offline while decoding symbols.



When the buffer is full, no more codes are read. The reader does not discard the oldest read, the reader beeps and the status indicator changes to WHITE.



Summary of Wireless Buffering Indicators

Condition	Status Indicator: Reader	Status Indicator: Base Station	Sounds
Reader in wireless range of base station	When the reader is awake, blinking BLUE indicates wireless connection with the base. When the reader is offline, there is no indicator. Pull the trigger to wake it up and it will blink BLUE. Good read: GREEN No read: RED	Reader out of the base station and awake: steady BLUE. Reader out of the base station and offline: steady RED. Paired reader in the base station: flashing GREEN. Base station is receiving data or images from reader: steady BLUE.	Good read: 1 beep (default) No read: no beep (default)
Reader out of wireless range or base station	Offline: When the reader wakes up out of the wireless range, there is no indicator. Good read: GREEN (default) No read: RED (default)	Reader offline: steady RED.	Long beep when you leave the wireless range. Good read: 2 beeps No read: no beep
Reader out of wireless range of base station, buffer is full	Good read: GREEN and then white. No read: RED (default)	Reader offline: steady RED.	Good read: long beep No read: no beep

Charging

When you are reading codes with your wireless reader, blinking red status indicators signal a low battery. As the battery discharges, the blink frequency increases. A blinking red status indicator indicates low battery or thermal shutdown mode.



You can also check the status of the battery in the DataMan Setup Tool.

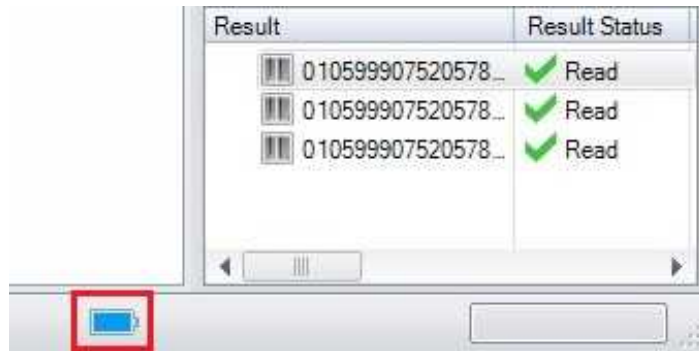

Place the reader on the base station for charging. Make sure that the pins at the end of the handle make contact with the pins in the base station.

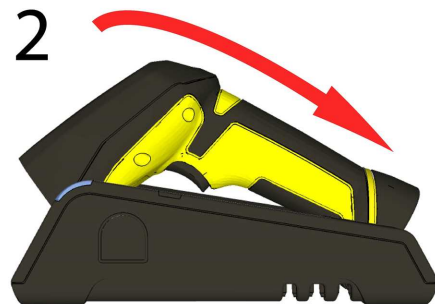



Paired Reader Charging



Paired Reader Fully Charged

Summary of indicator charging signals:

Condition	Status Indicator: Reader	Status Indicator: Base Station
Battery low, Reader is off base station	blinking RED indicators	steady BLUE, indicating connection steady RED, indicating no connection
Reader is charging in the base station	steady RED indicators	steady GREEN, indicating connection blinking GREEN, indicating data transfer
Reader is fully charged in the base station	steady GREEN indicators	steady GREEN, indicating connection blinking GREEN, indicating data transfer

Changing Batteries

To change batteries, perform the following steps:

1. Twist the reader's end cap, and take it off.

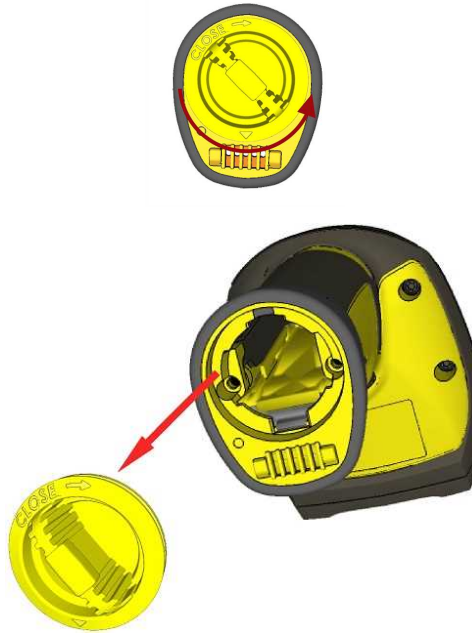

2. Hold the reader in an upright position and the battery slides out of the handle.

i Note: You may need to shake the reader slightly.



WARNING: The battery used in these devices may present a risk of fire or chemical burn if mistreated. Do not disassemble, heat above 60 °C (140 °F), or incinerate. Replace battery with Cognex DMA-HHBATTERY-01 only. Any other battery may present a risk of fire or explosion.

- Put the replacement battery into the slot with the metal contact pins pushed in first. A small triangle on one side of the battery is indicating the correct placement.

 **Tip:** A small triangle on one side of the battery is also indicating the correct placement.

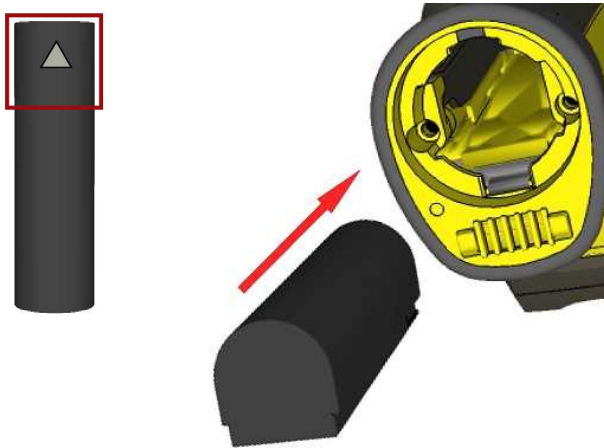

- Put the end cap back on and twist it. Make sure that the triangle aligns with the circle when the cover is locked.

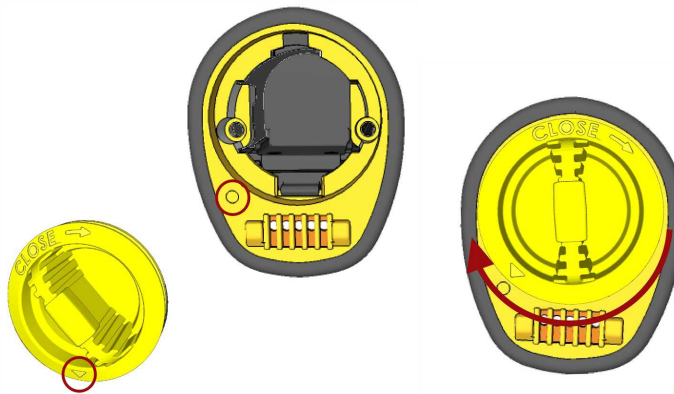

5. If using DMA-CBASE-01, place the battery in the spare battery charger in the direction of the small triangle of the battery.

i Note: On Bluetooth chargers, DMA-IBASE-BT-01 and DMA-IBASE-BT-02 battery charging is not available.



Note:

i When you are charging the auxiliary battery, the base station's spare battery status indicator displays either charging in progress (RED) or fully charged (GREEN).

! WARNING: Dispose of the used battery promptly. Keep it away from children. Do not disassemble and do not burn it. Use the appropriate separate take-back systems for battery disposal.

Reading Codes with the DataMan 8050

Industrial Protocols

The DataMan 8050 readers support the following industrial protocols:

- EtherNet/IP™
- PROFINET
- SLMP Protocol
- Modbus TCP

Select the industrial protocol tools and sample programs when installing the DataMan Setup Tool.

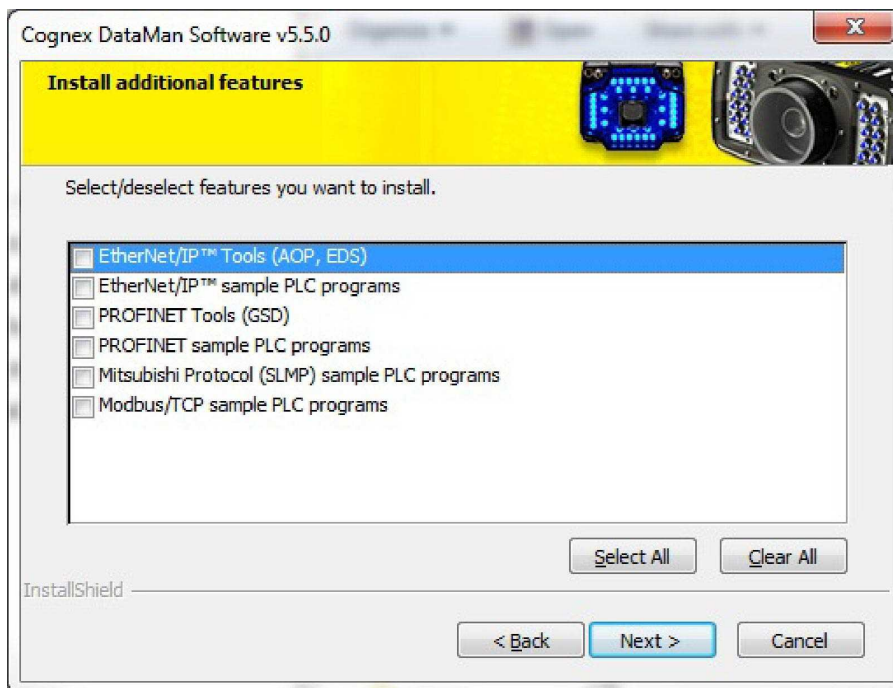

There are three ways to enable or disable Industrial Protocols. Using either method, rebooting the reader is required for the changes to take effect.

- Enable the protocols using the **Industrial Protocols** pane of the DataMan Setup Tool under **Communication Settings**.
- Scan the appropriate **Reader Configuration codes** (see the **Reader Configuration Codes Manual** available through the Windows **Start** menu, the Setup Tool **Help** menu, or the [Cognex Documentation Portal](#)).
- Send the appropriate **DMCC** (see the **DataMan Control Commands Documentation** available through the Windows **Start** menu or the Setup Tool **Help** menu).

For more information on using the industrial protocols, see the **Industrial Protocols Manual** available through the Windows **Start** menu, the Setup Tool **Help** menu, or the [Cognex Documentation Portal](#).

Trigger Types

The DataMan 8050 trigger mode determines when the reader attempts to read a code. Use the DataMan Setup Tool or the appropriate reader configuration codes to change trigger types.

Supported trigger types:

- Manual (default): Pressing the trigger button on the reader starts image acquisition. The reader continues to acquire images until there is a detectable and decoded image or until the release of the trigger button.
- Presentation: The LED aimer is always on. When motion is detected in front of the reader, the reader turns on and scans for a symbol. The reader relies on an internal timing mechanism to acquire images.

Note: While in Presentation mode, pulling the trigger switches the reader to Manual mode until the device is re-docked on the base station. Setup Tool continues to display Presentation mode while in this state. To bring the reader back to Presentation mode, use one of the following options:

- Dock the device into the base station
- Switch to Manual trigger mode in Setup Tool, then switch back to Presentation mode
- Scan the Enter Presentation Reader Configuration Code

Field of View and Reading Distances

The following map shows the range of reading distances available for different code sizes and focus positions.

DataMan 8050 field of view and reading distances:

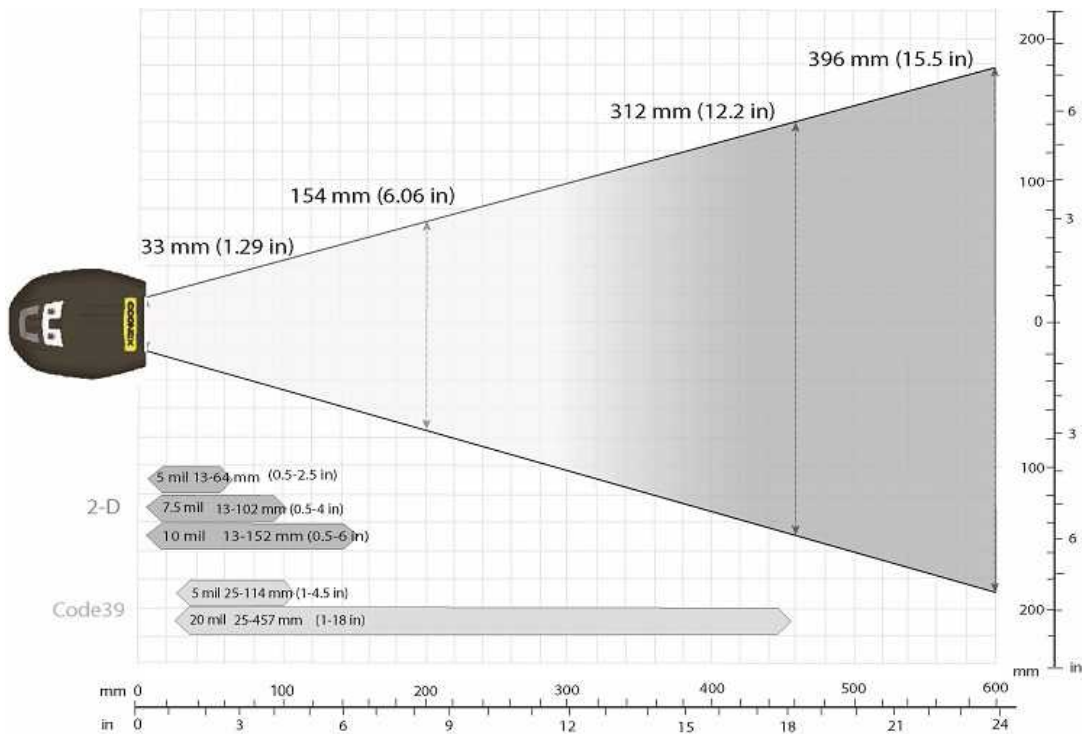

DataMan 8050HDX field of view and reading distances:



Note: Due to tolerances, ranges can vary by +/- 5 mm for small codes to +/- a couple of centimeters for large codes.

Note: All values beginning with 0 denote the minimum distance where the Field of View is able to see the entire code.

Cleaning and Maintenance

Cleaning the Reader Housing

To clean the outside of the reader housing, use a small amount of mild detergent cleaner or isopropyl alcohol on a cleaning cloth. Do not pour the cleaner on the reader housing.

 **CAUTION:** Do not attempt to clean any DataMan product with harsh or corrosive solvents, including lye, methyl ethyl ketone (MEK) or gasoline.

Cleaning the Reader Lens Cover

To remove dust from the lens cover, use a pressurized air duster. The air must be free of oil, moisture or other contaminants that could remain on the lens cover. To clean the plastic window of the lens cover, use a small amount of isopropyl alcohol on a cleaning cloth. Do not scratch the plastic window. Do not pour the alcohol on the plastic window.

Compliance Information, Warnings and Notices

Regulations and Conformity

The DataMan 8050 has Regulatory Model 1AAH, wireless slide-in has Regulatory model 1ABB, and the Bluetooth slide-in has Regulatory model 1AAJ, and meets or exceeds the requirements of all applicable standards organizations for safe operation. However, as with any electrical equipment, the best way to ensure safe operation is to operate them according to the agency guidelines that follow. Please read these guidelines carefully before using your device.

Note: For the most current CE declaration and regulatory conformity information, see the Cognex support site: cognex.com/support.

Regulator	Specification
USA	FCC Part 15B, Class A
Canada	ICES-003
European Community	EN55022, Class A EN61000-6-2 EN61000-6-4 EN60950

The following table shows Safety and Regulatory Information for corded readers:

Safety and Regulatory	
Manufacturer	Cognex Corporation One Vision Drive Natick, MA 01760 USA
CE	This is a class A product. In a domestic environment this product may cause radio interference in which case the user may be required to take immediate measures. This equipment complies with the essential requirements of the EU Directive 2014/30/EU. Declarations are available from your local representative.
EU RoHS	Compliant to the most recent applicable directive.
FCC	FCC Part 15, Class A This equipment has been tested and found to comply with the limits for a Class A digital device, pursuant to part 15 of the FCC Rules. These limits are designed to provide reasonable protection against harmful interference when the equipment is operated in a commercial environment. This equipment generates, uses, and can radiate radio frequency energy and, if not installed and used in accordance with the instruction manual, may cause harmful interference to radio communications. Operation of this equipment in a residential area is likely to cause harmful interference in which case the user will be required to correct the interference at his own expense.
Canadian Compliance	This Class A digital apparatus complies with Canadian ICES-003. Cet appareil numérique de la classe A est conforme à la norme NMB-003 du Canada.
TÜV	DataMan 8050: Regulatory Model 1AAH DataMan 8050 wireless slide-in: Regulatory model 1ABB DataMan 8050 bluetooth slide-in: Regulatory model 1AAJ NRTL: TÜV SÜD SCC/NRTL OSHA Scheme for UL/CAN 61010-1. CB report available upon request. TÜV SÜD IEC/EN 61010-1.

Safety and Regulatory	
Brazilian Compliance	 <p>This 1AAJ Bluetooth slide-in with model number DMCM-BTM-00 has frequency range between 2.402 GHz and 2.480 GHz. Its Bluetooth specification is 2.1, 2.4 GHz with FHSS modulation, PCB antenna with 3dB peak antenna gain.</p>
Mexican Compliance	For Bluetooth: RCPC01A15-0074 For wifi: RCPC01A15-1366
Chinese Compliance	For Bluetooth: CMIIT ID: 2015DJ0236 For wifi: CMIIT ID: 2015DJ3460

The following specifications apply to the DataMan 8050 wireless readers:

Regulator	Specification
USA	FCC Part 15B, Class A FCC Part 15.247
Canada	ICES-003 RSS 210
European Community	For Bluetooth: EN301 489-1 / -17 EN55022 EN55024
	For WiFi: EN300 328 EN61000-6-2

The following table shows Safety and Regulatory Information for wireless readers:

Compliance Statements: DataMan Base Station

The DataMan Base Stations have the following Regulatory models respectively: DMA-IBASE-01 has R00043, DMA-IBASE-BT-XX has 1AAG, DMA-CBASE-01 has R00046, and they meet or exceed the requirements of all applicable standards organizations for safe operation. However, as with any electrical equipment, the best way to ensure safe operation is to operate them according to the agency guidelines that follow.

Note: For the most current CE declaration and regulatory conformity information, see the Cognex support site: cognex.com/support.

Please read these guidelines carefully before using your device.

Regulator	Specification
USA	FCC Part 15B, Class A FCC Part 15.247
Canada	ICES-003
European Community	EN301 489-1 / -17 EN300 328-2 EN60950

Safety and Regulatory	
Manufacturer	Cognex Corporation One Vision Drive Natick, MA 01760 USA
CE	DMA-IBASE-BT-XX DMA-IBASE-01 DMA-CBASE-01 This is a class A product. In a domestic environment this product may cause radio interference in which case the user may be required to take immediate measures. This equipment complies with the essential requirements of EU Directives 2014/30/EU and 2014/53/EU. Declarations are available from your local representative.
EU RoHS	Compliant to the most recent applicable directive.
FCC	FCC Part 15, Class A This equipment has been tested and found to comply with the limits for a Class A digital device, pursuant to part 15 of the FCC Rules. These limits are designed to provide reasonable protection against harmful interference when the equipment is operated in a commercial environment. This equipment generates, uses, and can radiate radio frequency energy and, if not installed and used in accordance with the instruction manual, may cause harmful interference to radio communications. Operation of this equipment in a residential area is likely to cause harmful interference in which case the user will be required to correct the interference at his own expense.
Canadian Compliance	This Class A digital apparatus complies with Canadian ICES-003. Cet appareil numérique de la classe A est conforme à la norme NMB-003 du Canada.
TÜV	DataMan 8050 Base Station Regulatory Model R00087 NRTL: TÜV SÜD SCC/NRTL OSHA Scheme for UL/CAN 61010-1. CB report available upon request. TÜV SÜD IEC/EN 61010-1.
Mexican Compliance	DMA-IBASE-BT-XX: RCPCO1A15-0073 DMA-IBASE-01: RCPCODM12-0655
Chinese Compliance	DMA-IBASE-BT-XX: CMIIT ID: 2015DJ0237 DMA-IBASE-01: CMIIT ID: 2012DJ2857

For European Community Users

Cognex complies with Directive 2012/19/EU OF THE EUROPEAN PARLIAMENT AND OF THE COUNCIL of 4 July 2012 on waste electrical and electronic equipment (WEEE).

This product has required the extraction and use of natural resources for its production. It may contain hazardous substances that could impact health and the environment, if not properly disposed.

In order to avoid the dissemination of those substances in our environment and to diminish the pressure on the natural resources, we encourage you to use the appropriate take-back systems for product disposal. Those systems will reuse or recycle most of the materials of the product you are disposing in a sound way.



The crossed out wheeled bin symbol informs you that the product should not be disposed of along with municipal waste and invites you to use the appropriate separate take-back systems for product disposal.

If you need more information on the collection, reuse, and recycling systems, please contact your local or regional waste administration.

You may also contact your supplier for more information on the environmental performance of this product.

中国大陆RoHS (Information for China RoHS Compliance)

根据中国大陆《电子信息产品污染控制管理办法》(也称为中国大陆RoHS), 以下部份列出了本产品中可能包含的有毒有害物质或元素的名称和含量。



Table of toxic and hazardous substances/elements and their content, as required by China's management methods for controlling pollution by electronic information products.

Part Name 部件名称	Hazardous Substances 有害物质					
	Lead (Pb) 铅	Mercury (Hg) 汞	Cadmium (Cd) 镉	Hexavalent Chromium (Cr (VI)) 六价铬	Polybrominated biphenyls (PBB) 多溴联苯	Polybrominated diphenyl ethers (PBDE) 多溴二苯醚
Regulatory Model 1AAH Regulatory Model 1ABB Regulatory Model 1AAJ Regulatory Model R00043 Regulatory Model 1AAG Regulatory Model R00046	X	O	O	O	O	O
<p>This table is prepared in accordance with the provisions of SJ/T 11364. 这个标签是根据SJ/T 11364 的规定准备的。</p> <p>O: Indicates that said hazardous substance contained in all of the homogeneous materials for this part is below the limit requirement of GB / T26572 - 2011. 表示本部件所有均质材料中含有的有害物质低于GB / T26572 - 2011 的限量要求。</p> <p>X: Indicates that said hazardous substance contained in at least one of the homogeneous materials used for this part is above the limit requirement of GB / T26572 - 2011. 表示用于本部件的至少一种均质材料中所含的危害物质超过GB / T26572 - 2011 的限制要求。</p>						

