

High-Speed Steerable Mirror Reference Manual



2024 July 18
Revision: 24.2.1.1

Legal Notices

The software described in this document is furnished under license, and may be used or copied only in accordance with the terms of such license and with the inclusion of the copyright notice shown on this page. Neither the software, this document, nor any copies thereof may be provided to, or otherwise made available to, anyone other than the licensee. Title to, and ownership of, this software remains with Cognex Corporation or its licensor. Cognex Corporation assumes no responsibility for the use or reliability of its software on equipment that is not supplied by Cognex Corporation. Cognex Corporation makes no warranties, either express or implied, regarding the described software, its merchantability, non-infringement or its fitness for any particular purpose.

The information in this document is subject to change without notice and should not be construed as a commitment by Cognex Corporation. Cognex Corporation is not responsible for any errors that may be present in either this document or the associated software.

Companies, names, and data used in examples herein are fictitious unless otherwise noted. No part of this document may be reproduced or transmitted in any form or by any means, electronic or mechanical, for any purpose, nor transferred to any other media or language without the written permission of Cognex Corporation.

Copyright © 2021. Cognex Corporation. All Rights Reserved.

Portions of the hardware and software provided by Cognex may be covered by one or more U.S. and foreign patents, as well as pending U.S. and foreign patents listed on the Cognex web site at: cognex.com/patents.

The following are registered trademarks of Cognex Corporation:

Cognex, 2DMAX, Advantage, AlignPlus, Assemblyplus, Check it with Checker, Checker, Cognex Vision for Industry, Cognex VSOC, CVL, DataMan, DisplayInspect, DVT, EasyBuilder, Hotbars, IDMax, In-Sight, Laser Killer, MVS-8000, OmniView, PatFind, PatFlex, PatInspect, PatMax, PatQuick, SensorView, SmartView, SmartAdvisor, SmartLearn, UltraLight, Vision Solutions, VisionPro, VisionView

The following are trademarks of Cognex Corporation:

The Cognex logo, 1DMax, 3D-Locate, 3DMax, BGAll, CheckPoint, Cognex VSoC, CVC-1000, FFD, iLearn, In-Sight (design insignia with cross-hairs), In-Sight 2000, InspectEdge, Inspection Designer, MVS, NotchMax, OCRMax, PatMax RedLine, ProofRead, SmartSync, ProfilePlus, SmartDisplay, SmartSystem, SMD4, VisiFlex, Xpand

Portions copyright © Microsoft Corporation. All rights reserved.

Portions copyright © MadCap Software, Inc. All rights reserved.

Other product and company trademarks identified herein are the trademarks of their respective owners.

Precautions

 **WARNING:** This device has been tested in accordance with IEC60825-1 3rd ed., 2014., and has been certified to be under the limits of a Class 1 Laser device. Wavelength 650 nm laser radiation.





To reduce the risk of injury or equipment damage, observe the following precautions when you install the Cognex product:

- The reader is intended to be supplied by a UL or NRTL listed power supply with a 24VDC output rated for at least 2A continuous and a maximum short circuit current rating of less than 8A and a maximum power rating of less than 100VA and marked Class 2 or Limited Power Source (LPS). Any other voltage creates a risk of fire or shock and can damage the components. Applicable national and local wiring standards and rules must be followed.
- This product is intended for industrial use in automated manufacturing or similar applications.
- The safety of any system incorporating this product is the responsibility of the assembler of the system.
- Do not install Cognex products where they are exposed to environmental hazards such as excessive heat, dust, moisture, humidity, impact, vibration, corrosive substances, flammable substances, or static electricity.
- Route cables and wires away from high-current wiring or high-voltage power sources to reduce the risk of damage or malfunction from the following causes: over-voltage, line noise, electrostatic discharge (ESD), power surges, or other irregularities in the power supply.
- Do not expose the image sensor to laser light. Image sensors can be damaged by direct, or reflected, laser light. If your application requires laser light that might strike the image sensor, use a lens filter at the corresponding laser wavelength. For suggestions, contact your local integrator or application engineer.
- This product does not contain user-serviceable parts. Do not make electrical or mechanical modifications to product components. Unauthorized modifications can void your warranty.
- Changes or modifications not expressly approved by the party responsible for regulatory compliance could void the user's authority to operate the equipment.
- Include service loops with cable connections.
- Ensure that the cable bend radius begins at least six inches from the connector. Cable shielding can be degraded or cables can be damaged or wear out faster if a service loop or bend radius is tighter than 10X the cable diameter.
- This device should be used in accordance with the instructions in this manual.
- All specifications are for reference purposes only and can change without notice.

Symbols

The following symbols indicate safety precautions and supplemental information:

 **WARNING:** This symbol indicates a hazard that could cause death, serious personal injury or electrical shock.

 **CAUTION:** This symbol indicates a hazard that could result in property damage.

 **Note:** This symbol indicates additional information about a subject.

 **Tip:** This symbol indicates suggestions and shortcuts that might not otherwise be apparent.

Table of Contents

Legal Notices	2
Precautions	3
Symbols	4
Table of Contents	5
Getting Started	6
About High Speed Steerable Mirror	6
Hardware Compatibility and Common Kits	7
Accessories	8
Recommended Lighting Accessories	8
Setting Up Your DataMan 470 Reader	10
Dimensions	10
Field of View	11
1-Axis Field of View	11
2-Axis Field of View	12
Scan Pattern	15
Using Your High Speed Steerable Mirror	16
Software Configuration	16
Steerable Mirror Wizard	16
DataMan Control Commands	17
Specifications	19
Reader Specification	19
DataMan Reader Imager Specifications	20
Cleaning and Maintenance	21
Cleaning the Housing	21
Cleaning the Cover	21
Regulations and Conformity	22
For European Community Users	22
中国大陆 RoHS (Information for China RoHS Compliance)	23

Getting Started

This section provides general information about the DataMan 470 series reader with High Speed Steerable Mirror. For more information on the DataMan 470 reader, please refer to the **DataMan 470 Series Reference Manual**.

About High Speed Steerable Mirror



⚠ WARNING: Do not detach the High Speed Steerable Mirror. Doing so results in the loss of warranty.

⚠ WARNING: This device has been tested in accordance with IEC60825-1 3rd ed., 2014., and has been certified to be under the limits of a Class 1 Laser device. Wavelength 650 nm laser radiation.



The following image shows the location of the label on the device:

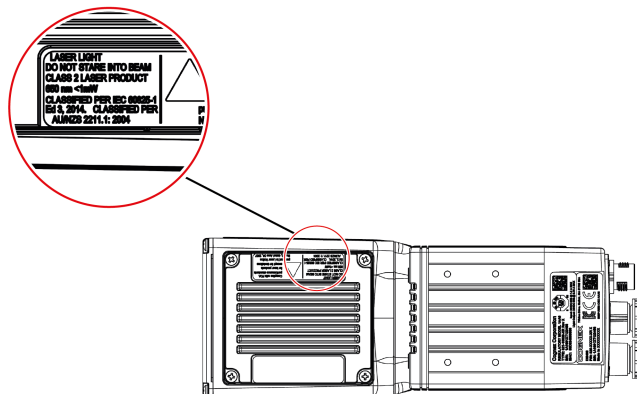

The High-Speed Steerable Mirror is a DataMan Fixed-Mount accessory that multiplies the field of view coverage of a single camera. The High-Speed Steerable Mirror dynamically steers the field of view and adjusts lens focus between image acquisitions. This accessory includes a steerable mirror module, time of flight sensor, laser aimer, and High-Speed Liquid Lens (HSSL).

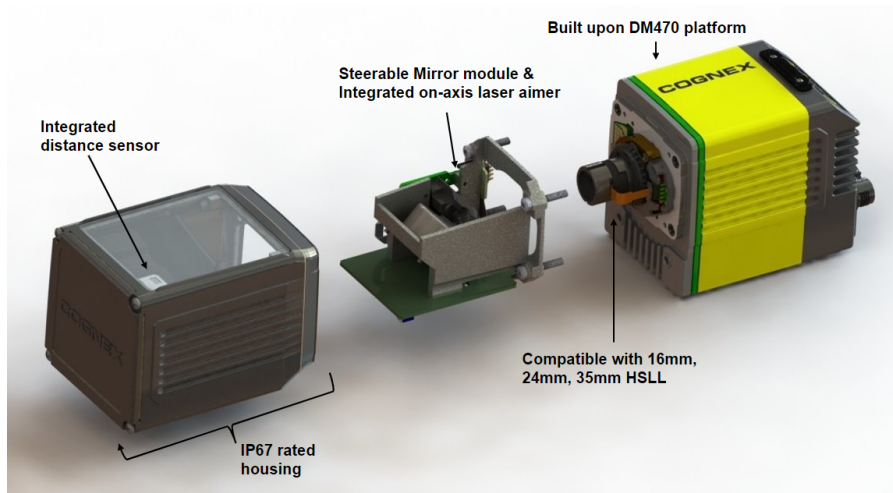

Hardware Compatibility and Common Kits

Observe the tables below for hardware compatibility and common kit configurations.

Reader	Feature Key	Scanning Range	High-Speed Liquid Lens
DM474	QL	1 Axis Scan Pattern	16 mm HSSL (474 only)
DM475	X	2 Axis Scan Pattern	24 mm HSSL
			35 mm HSSL

Product Number	Kit
DM-474QL-HSSM-12	DM474QL, 24mm HSSL, 1-axis mirror movement
DM-475X-HSSM-23	DM475X, 35mm HSSL, 2-axis mirror movement
DM-474X-HSSM-LAB	DM474X, 24mm HSSL, 2-axis mirror movement lab unit
DM470-KEY-HSSM-2AX	2-Axis Scan Pattern Feature Key

Note: For additional kit configurations, please contact your local Cognex sales representative.

Accessories

You can purchase the following components separately.

Note: For a list of options and accessories, contact your Cognex sales representative.

Note: The HSSM is compatible with all cables, brackets, and external lighting of the DataMan 470. For general DataMan 470 accessories, please refer to the **DataMan 470 Series Reference Manual**.

Recommended Lighting Accessories

For 1-Axis and 2-Axis scan patterns, based on the required coverage area, the available lighting configurations are:

	Required Coverage	Configuration	Part Number	Quantity
1-Axis	< 500 mm	Single L300-2X-W	IVSL-YLW2X-625-W	1
	500 - 800 mm	Single LX800-W	IVSL-LX800-625-W	1
	> 800 mm	Single DMBS Light	IVSL-DMBS6-625	1
2-Axis	< 500 mm ²	Single L300-2X-W	IVSL-YLW2X-625-W	1
	500 - 800 mm ²	Dual LX800-W	IVSL-LX800-625-W	2
	> 800 mm ²	Dual DMBS Light	IVSL-DMBS6-625	2

The following mounting orientations are recommended for the lighting configurations specified. Please observe the color coding below:

Square Color	Device
YELLOW	Lighting
BLACK	High Speed Steerable Mirror

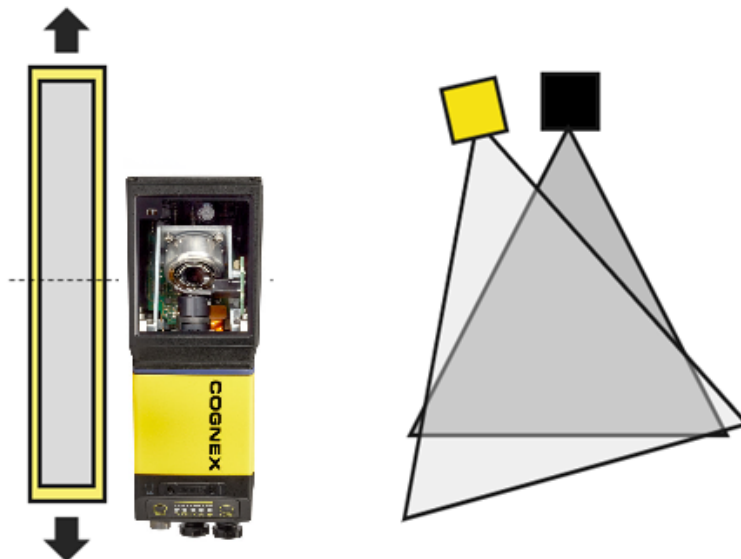

Single light for 1-axis mirror movement:

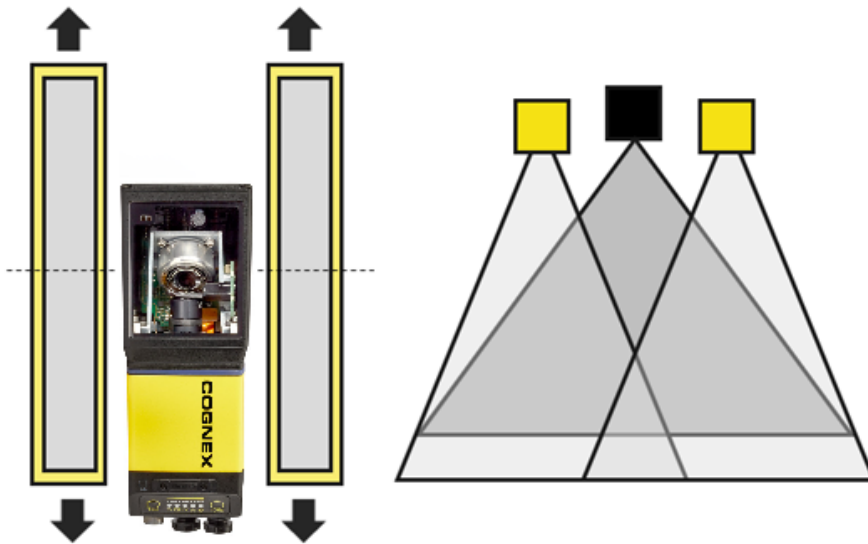

Dual lights for 2-axis, wide FoV applications:

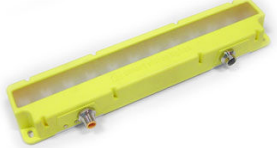

The accessories are available with the following product specifications:

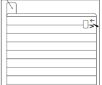
Accessory	Product ID	Image
300 mm bar light, wide projection	IVSL-YLW2X-625-W	
800 mm bar light, wide projection	IVSL-LX800-625-W	
1 m bar light	IVSL-DMBS6-625	
Linear Polarizers for HSSM (includes both vertical and horizontal orientations)	DM470-HSSM-LP	

Setting Up Your DataMan 470 Reader

Note: For information about mounting the reader, setting the focus, and connecting cables, refer to the **DataMan 470 Series Reference Manual**.

Dimensions

Observe the following dimensions when installing the reader.

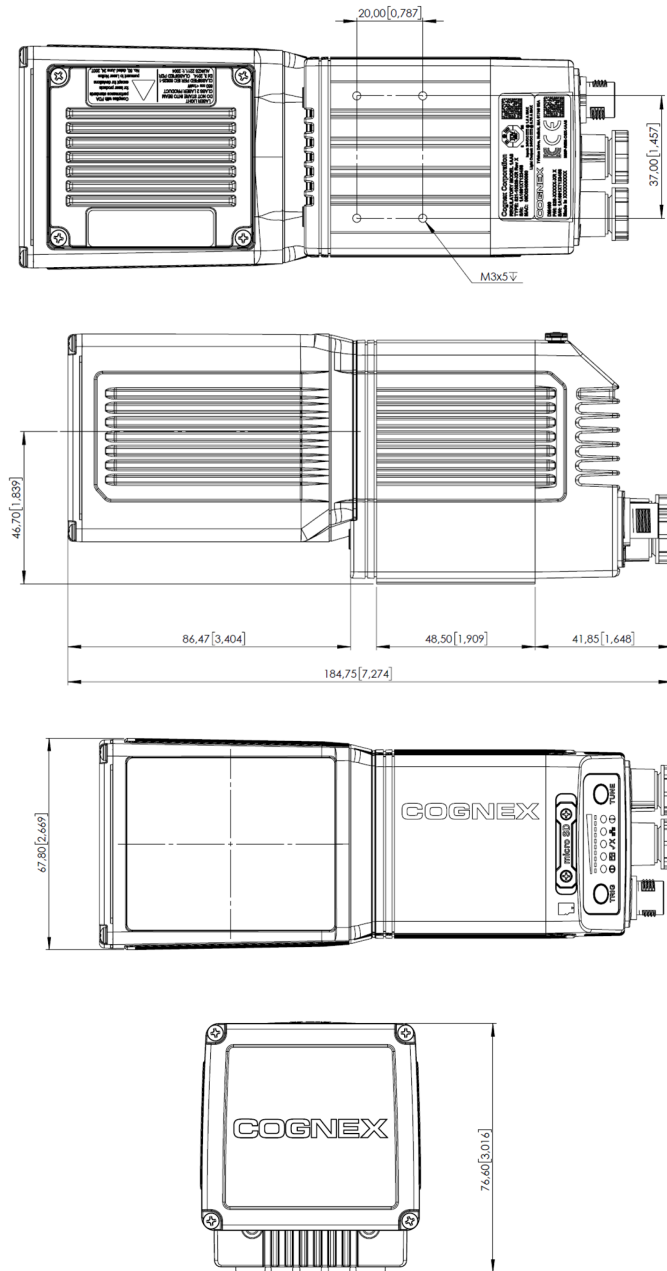

Field of View

The following maps show the field of view of the High Speed Steerable Mirror.

Note: Due to tolerances, ranges can vary by +/- 5 % from unit to unit.

1-Axis Field of View

The following field of view projections represent the approximate 1-Axis field of view achievable for 1D and 2D barcodes.

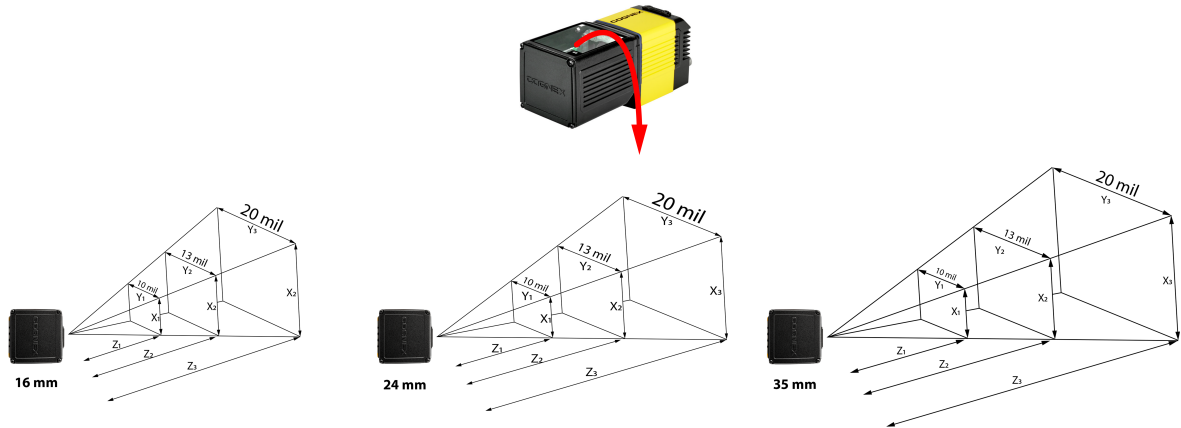

Field of view coverage for 1D codes (3 and 5 MP)

Reader	Lens	Module Size (mm)	Max Working Distance (mm)		Coverage (mm)		Coverage (mm)	
DM474	16mm	0.254 (10 mil)	Z1	830	Y1	900	X1	389
		0.339 (13 mil)	Z2	1100	Y2	1225	X2	516
		0.508 (20 mil)	Z3	1670	Y3	1950	X3	760
	24mm	0.254 (10 mil)	Z1	1060	Y1	2000	X1	325
		0.339 (13 mil)	Z2	1450	Y2	2600	X2	441
		0.508 (20 mil)	Z3	2150	Y3	4000	X3	645
	35mm	0.254 (10 mil)	Z1	1540	Y1	3000	X1	318
		0.339 (13 mil)	Z2	2060	Y2	4000	X2	423
		0.508 (20 mil)	Z3	3090	Y3	6000	X3	631
DM475	24mm	0.254 (10 mil)	Z1	1060	Y1	2000	X1	388
		0.339 (13 mil)	Z2	1450	Y2	2600	X2	527
		0.508 (20 mil)	Z3	2150	Y3	4000	X3	772
	35mm	0.254 (10 mil)	Z1	1540	Y1	3000	X1	380
		0.339 (13 mil)	Z2	2060	Y2	4000	X2	506
		0.508 (20 mil)	Z3	3090	Y3	6000	X3	754

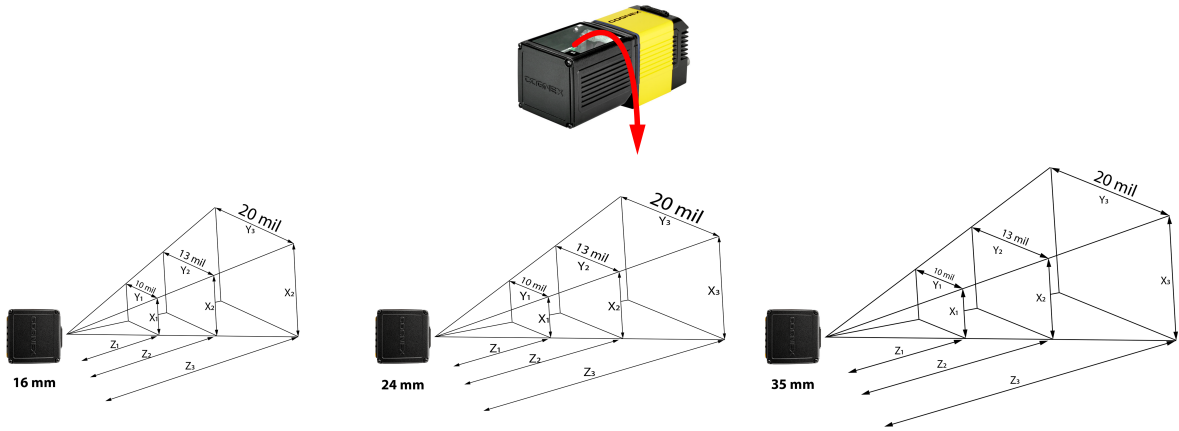

Field of view coverage for 2D codes (3 and 5 MP)

Reader	Lens	Module Size (mm)	Max Working Distance (mm)		Coverage (mm)		Coverage (mm)	
DM474	16mm	0.254 (10 mil)	Z1	370	Y1	475	X1	184
		0.339 (13 mil)	Z2	500	Y2	640	X2	244
		0.508 (20 mil)	Z3	780	Y3	950	X3	366
	24mm	0.254 (10 mil)	Z1	500	Y1	950	X1	158
		0.339 (13 mil)	Z2	660	Y2	1300	X2	209
		0.508 (20 mil)	Z3	1030	Y3	1900	X3	317
	35mm	0.254 (10 mil)	Z1	740	Y1	1450	X1	156
		0.339 (13 mil)	Z2	980	Y2	1950	X2	205
		0.508 (20 mil)	Z3	1480	Y3	2900	X3	306
DM475	24mm	0.254 (10 mil)	Z1	500	Y1	950	X1	192
		0.339 (13 mil)	Z2	660	Y2	1300	X2	250
		0.508 (20 mil)	Z3	1030	Y3	1900	X3	380
	35mm	0.254 (10 mil)	Z1	740	Y1	1450	X1	156
		0.339 (13 mil)	Z2	980	Y2	1950	X2	245
		0.508 (20 mil)	Z3	1480	Y3	2900	X3	366

2-Axis Field of View

The following field of view projections represent the approximate rectangular field of view size achievable when utilizing 2-axis mirror movement.

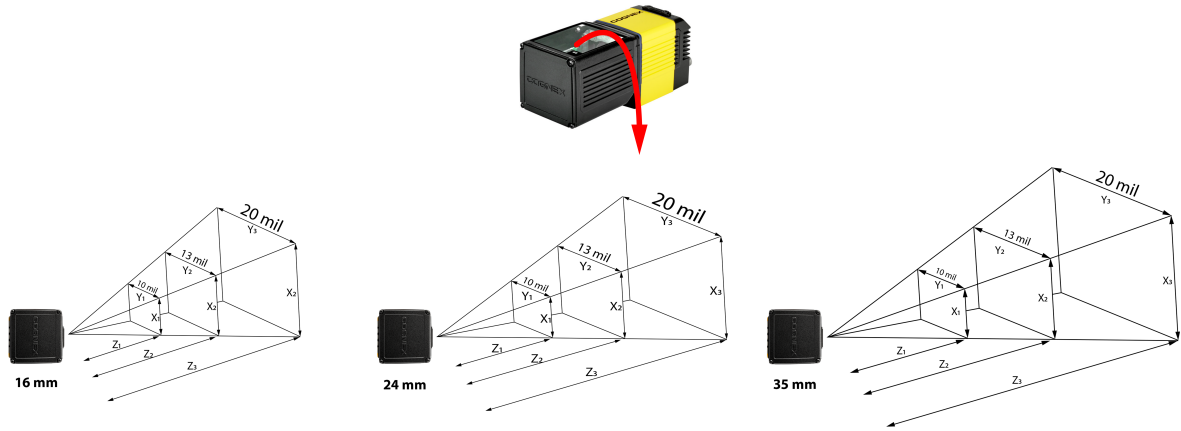

Field of view coverage for stationary 1D codes (3 and 5 MP)

Reader	Lens	Module Size (mm)	Max Working Distance (mm)		Coverage (mm)		Coverage (mm)	
DM474	16mm	0.254 (10 mil)	Z1	850	Y1	850	X1	700
		0.339 (13 mil)	Z2	1130	Y2	1130	X2	930
		0.508 (20 mil)	Z3	1690	Y3	1690	X3	1390
	24mm	0.254 (10 mil)	Z1	1190	Y1	1580	X1	1250
		0.339 (13 mil)	Z2	1590	Y2	2110	X2	1670
		0.508 (20 mil)	Z3	2380	Y3	3160	X3	2500
	35mm	0.254 (10 mil)	Z1	1750	Y1	2500	X1	1750
		0.339 (13 mil)	Z2	2340	Y2	3340	X2	2340
		0.508 (20 mil)	Z3	3510	Y3	5010	X3	3510
DM475	24mm	0.254 (10 mil)	Z1	1190	Y1	1580	X1	1250
		0.339 (13 mil)	Z2	1590	Y2	2110	X2	1670
		0.508 (20 mil)	Z3	2380	Y3	3160	X3	2500
	35mm	0.254 (10 mil)	Z1	1750	Y1	2500	X1	1750
		0.339 (13 mil)	Z2	2340	Y2	3340	X2	2340
		0.508 (20 mil)	Z3	3510	Y3	5010	X3	3510

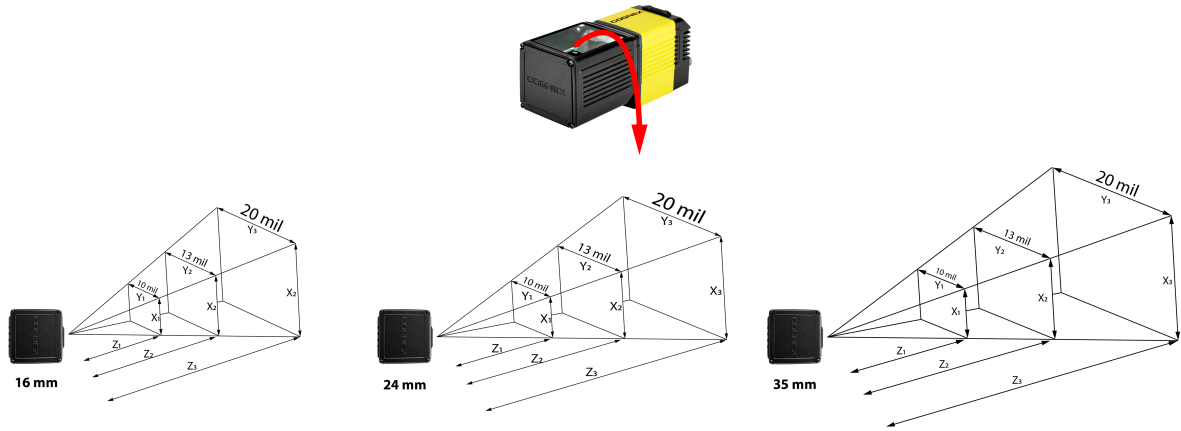

Field of view coverage for 2D codes (3 and 5MP)

Reader	Lens	Module Size (mm)	Max Working Distance (mm)		Coverage (mm)		Coverage (mm)	
DM474	16mm	0.254 (10 mil)	Z1	405	Y1	405	X1	350
		0.339 (13 mil)	Z2	540	Y2	540	X2	470
		0.508 (20 mil)	Z3	810	Y3	810	X3	700
	24mm	0.254 (10 mil)	Z1	570	Y1	760	X1	600
		0.339 (13 mil)	Z2	760	Y2	1010	X2	800
		0.508 (20 mil)	Z3	1140	Y3	1510	X3	1200
	35mm	0.254 (10 mil)	Z1	840	Y1	1200	X1	840
		0.339 (13 mil)	Z2	1120	Y2	1600	X2	1120
		0.508 (20 mil)	Z3	1680	Y3	2400	X3	1680
DM475	24mm	0.254 (10 mil)	Z1	570	Y1	760	X1	600
		0.339 (13 mil)	Z2	760	Y2	1010	X2	800
		0.508 (20 mil)	Z3	1140	Y3	1510	X3	1200
	35mm	0.254 (10 mil)	Z1	840	Y1	1200	X1	840
		0.339 (13 mil)	Z2	1120	Y2	1600	X2	1120
		0.508 (20 mil)	Z3	1680	Y3	2400	X3	1680

Scan Pattern

Typical use cases of the High Speed Steerable Mirror include the following:

1-Axis Mirror Movement for Moving Targets



- Inbound pallet side scanning
- Conveyor scanning

2-Axis Mirror Movement for Stationary Targets



- PCB scanning
- Product aggregation
- Manual product ID (PID)

Using Your High Speed Steerable Mirror

Note: For information about installing Setup Tool, triggering, and training the reader, refer to the **DataMan 470 Series Reference Manual**.

Software Configuration

To configure a reader with High Speed Steerable Mirror, install the DataMan Setup Tool software on a networked PC. For more information, see the DataMan support site, <http://www.cognex.com/support/dataman>.

1. Check the DataMan **Release Notes** for a full list of system requirements.
2. Download the DataMan Setup Tool from <http://www.cognex.com/support/dataman> and follow the on-screen steps.
3. Connect the reader with High Speed Steerable Mirror to your PC.
4. Launch the DataMan Setup Tool and click **Refresh**.
Detected readers will appear under **COM ports** or **Network devices**, or both.
5. Right click the appropriate reader from the list, and click **Open WebHMI In Browser**.

Note: Use Setup Tool to set up general reader settings and use the Steerable Mirror Wizard to configure the scan area and trigger settings.

Steerable Mirror Wizard

Steerable Mirror Wizard is a built-in web-based setup wizard allowing operators to deploy an application quickly and effectively. The wizard opens in your web browser, where you can automatically program the steerable mirror operation. Define the application specifications:

1. Target specifications:
 - a. Define the target face for scanning (Top or Side).
 - b. Define if the target is stationary or moving, and whether the barcode placements are known or not.
 - c. Define the maximum of target dimensions.
 - d. Define the code dimensions and orientations.
2. Device placement:
 - a. Define the maximum working distance to target.
 - b. Define the device orientation.
 - c. Define device offset from center of target.

Based on the specifications, the device, and lens used, the software automatically generates a scan pattern and programs it on the device.

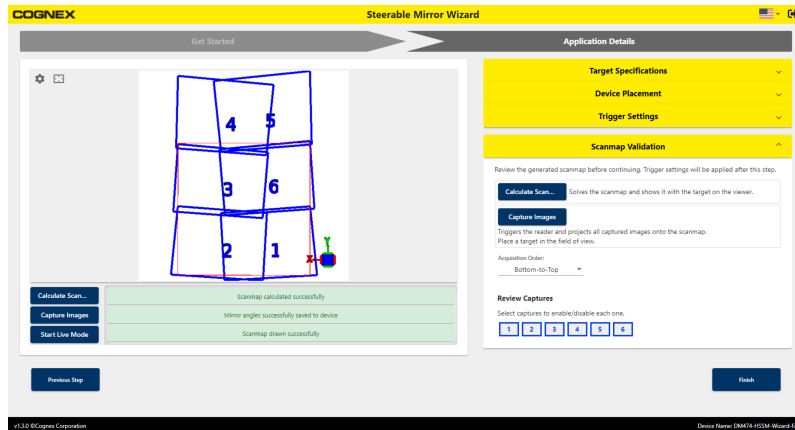

DataMan Control Commands

Mirror paths and positions are manually programmed on the device through the use of DataMan Control Commands (DMCC) via Telnet or Serial interface. For more information on DMCC communications, please refer to the **DataMan Communications and Programming Guide**.

All DMCC commands related to the high speed steerable mirror use the following internal coordinate system, where α is used to denote motion along the vertical axis, and β is used to denote motion along the horizontal axis.

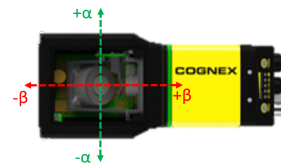
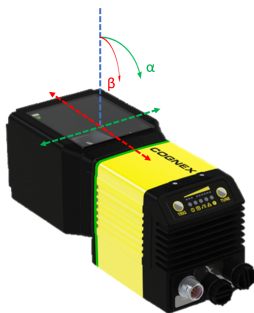

Configuration	Angle Limitations
1-Axis Scan Pattern	$0^\circ\alpha, \pm 25^\circ\beta$
2-Axis Scan Pattern	$\pm 17^\circ\alpha, \pm 17^\circ\beta$

Name	Set/Get	Args	Range	Meaning	Description
MIRROR.PATH	SET GET	string data	[0-512]	<number_of_positions>: < α 0>, < β 0>; < α 1>, < β 1>;..." Example: SET MIRROR.PATH 2:10.5,10.5;10.5,10.5;	Maximum of 64 positions with the precision of 0.001° . Sets/gets the mirror path sequence followed during triggering. Specify each value in a floating point format. (For example, 10° as 10.0.)
MIRROR.CURRENT-INDEX	SET GET	uint8 index	[0-63]	SET MIRROR.CURRENT-INDEX 0	Gets/sets the current mirror position. GET immediately moves the mirror to the desired position
MIRROR.ANGLE-POSITION	SET GET	uint8 index float α float β	[0-63]	SET MIRROR.ANGLE-POSITION 2 10.5 10.5	Get/set the stored angle values corresponding to the given path position index. For single axis motion, α or β may be expanded to $\pm 25.000^\circ$.

Name	Set/Get	Args	Range	Meaning	Description
MIRROR.POSITIONS	GET			GET MIRROR. POSITIONS	Get the number of positions used in the mirror path. Returned value: 0-63.

Specifications

The following sections list general specifications for the reader.

Reader Specification

Specification	DM474 Variant	DM475 Variant
Weight	718 g	
Power	24 VDC \pm 10%	
Power Consumption	24 VDC \pm 10%, 1.5 A maximum Supplied by LPS or NEC class 2 only	
Trigger and Tune Buttons	Yes; Quick Setup Intelligent Tuning	
Laser Aimer	Included	
Discrete Inputs	2 fixed + (*) opto-isolated	
Discrete Outputs	2 fixed + (*) opto-isolated	
*Other I/O Points	2 user-configurable	
Status Outputs	Beeper, 5 multifunctional LEDs, 10 LED bar array, 360 degree indicator	
Lighting	Various controllable external light options	
Communications	Ethernet and Serial	
Protocols	RS-232, TCP/IP, PROFINET, EtherNet/IP(TM), SLMP, Modbus TCP, NTP, SFTP, FTP, MRS Java Scripting enabled for custom protocols	
Dimensions	L: 184.8 mm, W: 67.8 mm, H: 77.8 mm	
Operating Temperature	0–57 °C (32–134.6 °F) ¹	
Storage Temperature	-20–80 °C (-4–176 °F)	
Operating and Storage Humidity	< 95% non-condensing	
Protection	IP67 with cables	
RoHS Certified	Yes	
Approvals (CE, UL, FCC)	Yes	
Vibration Spec	9 GRMS for 1.5hrs	
Angle of Deflection	-40° to +40°	
Software Models	QL, X	

^{1 2} In situations where the operating temperature exceeds 40 °C, an external heat sink is required.

DataMan Reader Imager Specifications

Specification	DM474 Variant	DM475 Variant
Image Sensor	1/1.8" CMOS	2/3" CMOS
Image Sensor Properties	Diagonal 8.9 mm; 3.45 μ m square pixels	Diagonal 11.1 mm; 3.45 μ m square pixels
Image Sensor Resolution	2048 x 1536	2448 x 2048
Electronic Shutter Speed	Min. exposure: 15 μ s Max. exposure: 1000 μ s with internal illumination/10000 μ s with external illumination	
Max Acquisition	Up to 55 Hz	Up to 37 Hz
Algorithms and Technologies	1DMax, 2DMax, Hotbars, PowerGrid	
Lens Options	Liquid lens 16 mm, 24 mm, 35mm	Liquid lens 24mm, 35mm

Cleaning and Maintenance

Cleaning the Housing

To clean the outside of the reader housing, use a small amount of mild detergent cleaner or isopropyl alcohol on a cleaning cloth. Do not pour the cleaner directly onto the reader housing.



CAUTION: Do not attempt to clean any DataMan product with harsh or corrosive solvents, including lye, methyl ethyl ketone (MEK) or gasoline.

Cleaning the Cover

To remove dust from the cover, use a pressurized air duster. The air must be free of oil, moisture or other contaminants that could remain on the cover. To clean the window of the cover, use a small amount of isopropyl alcohol on a cleaning cloth. Do not scratch the window. Do not pour the alcohol directly on the window.

Regulations and Conformity

The DataMan 470 reader with High Speed Steerable mirror has Regulatory Model R00062 and meets or exceeds the requirements of all applicable standards organizations for safe operation. However, as with any electrical equipment, the best way to ensure safe operation is to operate them according to the agency guidelines that follow. Please read these guidelines carefully before using your device.

WARNING: This device has been tested in accordance with IEC60825-1 3rd ed., 2014., and has been certified to be under the limits of a Class 1 Laser device. Wavelength 650 nm laser radiation.



Note: For the most current CE declaration and regulatory conformity information, see the Cognex support site: cognex.com/support.

Safety and Regulatory	
Manufacturer	Cognex Corporation One Vision Drive Natick, MA 01760 USA
CE	Regulatory Model R00062 This is a class A product. In a domestic environment this product may cause radio interference in which case the user may be required to take immediate measures. This equipment complies with the essential requirements of the EU Directive 2014/30/EU. Declarations are available from your local representative.
EU RoHS	Compliant to the most recent applicable directive.
FCC	FCC Part 15, Class A This equipment has been tested and found to comply with the limits for a Class A digital device, pursuant to part 15 of the FCC Rules. These limits are designed to provide reasonable protection against harmful interference when the equipment is operated in a commercial environment. This equipment generates, uses, and can radiate radio frequency energy and, if not installed and used in accordance with the instruction manual, may cause harmful interference to radio communications. Operation of this equipment in a residential area is likely to cause harmful interference in which case the user will be required to correct the interference at his own expense.
Korea 	R-REM-CGX-R00062 This device is certified for office use only and if used at home, there can be frequency interference problems.
TÜV	Regulatory Model R00062
	NRTL: TÜV SÜD SCC/NRTL OSHA Scheme for UL/CAN 61010-1.
	CB report available upon request. TÜV SÜD, IEC/EN 61010-1.

For European Community Users

Cognex complies with Directive 2012/19/EU OF THE EUROPEAN PARLIAMENT AND OF THE COUNCIL of 4 July 2012 on waste electrical and electronic equipment (WEEE).

This product has required the extraction and use of natural resources for its production. It may contain hazardous substances that could impact health and the environment, if not properly disposed.

In order to avoid the dissemination of those substances in our environment and to diminish the pressure on the natural resources, we encourage you to use the appropriate take-back systems for product disposal. Those systems will reuse or recycle most of the materials of the product you are disposing in a sound way.



The crossed out wheeled bin symbol informs you that the product should not be disposed of along with municipal waste and invites you to use the appropriate separate take-back systems for product disposal.

If you need more information on the collection, reuse, and recycling systems, please contact your local or regional waste administration.

You may also contact your supplier for more information on the environmental performance of this product.

中国大陆RoHS (Information for China RoHS Compliance)

根据中国大陆《电子信息产品污染控制管理办法》(也称为中国大陆RoHS), 以下部份列出了本产品中可能包含的有毒有害物质或元素的名称和含量。



Part Name 部件名称	Hazardous Substances 有害物质					
	Lead (Pb) 铅	Mercury (Hg) 汞	Cadmium (Cd) 镉	Hexavalent Chromium (Cr (VI)) 六价铬	Polybrominated biphenyls (PBB) 多溴联苯	Polybrominated diphenyl ethers (PBDE) 多溴二苯醚
Regulatory Model R00062	X	O	O	O	O	O

This table is prepared in accordance with the provisions of SJ/T 11364.
这个标签是根据SJ/T 11364 的规定准备的。

O: Indicates that said hazardous substance contained in all of the homogeneous materials for this part is below the limit requirement of GB / T26572 - 2011.
表示本部件所有均质材料中含有的有害物质低于GB / T26572 - 2011 的限量要求。

X: Indicates that said hazardous substance contained in at least one of the homogeneous materials used for this part is above the limit requirement of GB / T26572 - 2011.
表示用于本部件的至少一种均质材料中所含的危害物质超过GB / T26572 - 2011 的限制要求。

