

DataMan[®] 70 Series Reference Manual



2024 December 20
Revision: 25.1.0.5

Legal Notices

The software described in this document is furnished under license, and may be used or copied only in accordance with the terms of such license and with the inclusion of the copyright notice shown on this page. Neither the software, this document, nor any copies thereof may be provided to, or otherwise made available to, anyone other than the licensee. Title to, and ownership of, this software remains with Cognex Corporation or its licensor. Cognex Corporation assumes no responsibility for the use or reliability of its software on equipment that is not supplied by Cognex Corporation. Cognex Corporation makes no warranties, either express or implied, regarding the described software, its merchantability, non-infringement or its fitness for any particular purpose.

The information in this document is subject to change without notice and should not be construed as a commitment by Cognex Corporation. Cognex Corporation is not responsible for any errors that may be present in either this document or the associated software.

Companies, names, and data used in examples herein are fictitious unless otherwise noted. No part of this document may be reproduced or transmitted in any form or by any means, electronic or mechanical, for any purpose, nor transferred to any other media or language without the written permission of Cognex Corporation.

Copyright © 2025. Cognex Corporation. All Rights Reserved.

Portions of the hardware and software provided by Cognex may be covered by one or more U.S. and foreign patents, as well as pending U.S. and foreign patents listed on the Cognex web site at: cognex.com/patents.

The following are registered trademarks of Cognex Corporation:

Cognex, 2DMAX, Advantage, AlignPlus, Assemblyplus, Check it with Checker, Checker, Cognex Vision for Industry, Cognex VSOC, CVL, DataMan, DisplayInspect, DVT, EasyBuilder, Hotbars, IDMax, In-Sight, Laser Killer, MVS-8000, OmniView, PatFind, PatFlex, PatInspect, PatMax, PatQuick, SensorView, SmartView, SmartAdvisor, SmartLearn, UltraLight, Vision Solutions, VisionPro, VisionView

The following are trademarks of Cognex Corporation:

The Cognex logo, 1DMax, 3D-Locate, 3DMax, BGAll, CheckPoint, Cognex VSoC, CVC-1000, FFD, iLearn, In-Sight (design insignia with cross-hairs), In-Sight 2000, InspectEdge, Inspection Designer, MVS, NotchMax, OCRMax, PatMax RedLine, ProofRead, SmartSync, ProfilePlus, SmartDisplay, SmartSystem, SMD4, VisiFlex, Xpand

Portions copyright © Microsoft Corporation. All rights reserved.

Portions copyright © MadCap Software, Inc. All rights reserved.

Other product and company trademarks identified herein are the trademarks of their respective owners.

Table of Contents

Legal Notices	2
Table of Contents	3
Symbols	5
Getting Started	6
About DataMan 70	6
Intended Use	6
Configuration	6
DataMan 70 Accessories	8
Lens Options	8
Filters	8
Lens Covers	9
Light Options	9
Cables	10
Power Supplies	10
Mounting Brackets	10
IO Modules	11
DataMan 70 Systems	11
Model Variants	11
Communication Module	12
15 pin Adapter Cable	12
9 Pin Adapter Cable	13
Serial I/O Adapter (DMA-SERIALREST-ST)	14
USB Connections	14
Connecting to EZCCM	15
Reader Layout	15
Indicator LED	16
Illumination Options	16
Dimensional Drawings	17
Setting Up Your DataMan 70	18
Mounting	18
Field of View and Reading Distances	19
DataMan 70 Readers with a 6.2 mm Lens	19
Short Range (Focused to 105 mm)	19
Long Range (Focused to 190 mm)	19
DataMan 70 Readers with a 16 mm Lens	20
Connections, Optics and Lighting	22
I/O Cable	22
RS-232 Cable	22
DataMan 70 Series Specifications	23
DataMan 70 Series Imager Specifications	24
LED Wavelengths	24
Using Your DataMan 70	25
Installing the DataMan Software	25

Setting the Focus Position	25
Trigger Modes	27
Training and Trigger Modes	27
Training	28
Wiring the Basic I/O Module	29
Output Wiring Example	29
Input Wiring Example	30
Multi-port Connections	31
Cleaning and Maintenance	33
Cleaning the Reader Housing	33
Cleaning the Reader Lens Cover	33
Precautions	34
Regulations/Conformity	35
LED Safety Statement	36
For European Community Users	36

Symbols

The following symbols indicate safety precautions and supplemental information:

 **WARNING:** This symbol indicates a hazard that could cause death, serious personal injury or electrical shock.

 **CAUTION:** This symbol indicates a hazard that could result in property damage.

 **Note:** This symbol indicates additional information about a subject.

 **Tip:** This symbol indicates suggestions and shortcuts that might not otherwise be apparent.

Getting Started

This section provides general information about the DataMan 70 series readers as well as about the DataMan 70 accessories and systems.

About DataMan 70



The DataMan 70 series readers are best in class ID readers, offering superior performance with the latest ID tools, flexibility to configure the reader in terms of lighting and optics to optimize the application, and an ease-of-use giving the user the ability to setup and deploy an application quickly and efficiently all without the need for PC:

- Superior performance, 1-D and 2-D code reading, including HotBars™
- Flexible optics/lighting allowing for the protection of your investment

The DataMan 70 readers provide support for USB communications.

Key highlights:

- 1DMax with HotBars™, best in class 1-D reading, best in class 2-D reading. Reading codes no other ID reader on the market can.

Intended Use

The DataMan 70 Series fixed-mount ID reader is an intelligent imager-based system for vision applications including reading of various kinds of 1-D and 2-D barcode symbols and highly contrasted, laser-marked direct part marks.

Configuration



This document provides basic information about how to configure and use DataMan 70 readers. Additional information is available through the Windows **Start** menu or the DataMan Setup Tool **Help** menu after you install the DataMan software on your PC:

- The **DataMan Communications and Programming Guide** shows you how to integrate your DataMan reader into your particular automation and factory environment.
Cognex->DataMan Software v x.x.x->Documentation->Communications->DataMan Communications and Programming Guide
- The **DataMan Industrial Protocols Manual** provides information on how to integrate DataMan readers into your particular environment using industrial protocols.
Cognex->DataMan Software v x.x.x->Documentation->Communications->DataMan Industrial Protocols Manual
- The **DataMan Reader Configuration Codes** document provides printable 2-D codes that you can use to configure the DataMan reader.
Cognex->DataMan Software v x.x.x->Documentation->English->Reader Configuration Codes
- The **DM70 Quick Reference Guide** provides essential information about the DM70 readers.
Cognex->DataMan Software v x.x.x->Documentation->English->DM70 Series->DM70 Quick Reference Guide

- The **DataMan Fixed-Mount Readers Reference** is a complete online hardware reference for the DataMan fixed-mount ID readers.
Cognex->DataMan Software v x.x.x->Documentation->English->DM70 ->Fixed-Mount Reference Manual
- The **DataMan Questions and Answers** document provides context-sensitive information. You can view this help inside the DataMan Setup Tool or as a stand-alone help file.
Cognex->DataMan Software v x.x.x->Documentation->DM70->Questions and Answers
- The **DataMan Control Commands** lists DataMan Control Commands with all relevant information. You can view this help inside the Setup Tool or as a stand-alone help file.
Cognex->DataMan Software v x.x.x->Documentation->English->DataMan Control Commands
- The **Setup Tool Reference Manual** describes the user interface of the DataMan Setup Tool software.
Cognex->DataMan Software v x.x.x->Documentation->English->Setup Tool Reference Manual
- The **Release Notes** list detailed system requirements and additional information about this DataMan software release.
Cognex->DataMan Software v x.x.x->Documentation->DataMan v x.x.x Release Notes

DataMan 70 Accessories

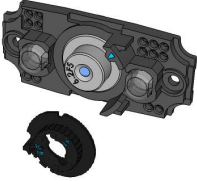
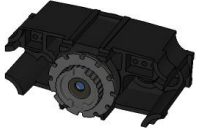
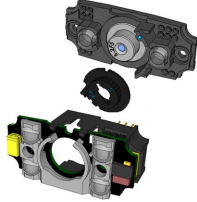
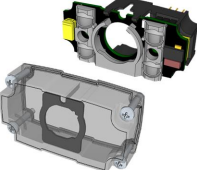
Lens Options



Accessory Name and Number	Accessory Image
<p>6.2 mm lens kit (DM150-LENS-62)</p> <ul style="list-style-type: none"> • 6.2 mm optics mount • 6.2 mm lens • manual lens cap (assembled) • screws 	
<p>16 mm lens with extended optics mount (requires the use of an extended front cover and high-powered red LED) (DM260-LENS-16)</p> <ul style="list-style-type: none"> • 16 mm optics mount • 16 mm lens • manual lens cap (assembled) • screws 	
<p>IR 6.2 mm lens kit, 3-position with IR LED (DMA-KIT-IR-62)</p> <ul style="list-style-type: none"> • 6.2 mm optics mount • 6.2 mm lens (IR) • Standard Infrared Light for 6.2mm (Risk Group Exempt acc. IEC62471) • manual lens cap (not assembled) • screws 	
<p>UV Light Kit for 6.2 mm lens (DMA-KIT-UV365-62) (Risk Group Exempt acc. IEC 62471)</p> <ul style="list-style-type: none"> • UV light board (365nm wavelength) • UV resistant front cover • screws 	
<p>IR 16 mm lens kit (DMA-KIT-IR-16)</p> <ul style="list-style-type: none"> • 16 mm optics mount • 16 mm lens (IR) • Standard Infrared Light for 16mm (Risk Group Exempt acc. IEC62471) • manual lens cap (assembled) • screws 	

Filters

Accessory Name and Number	Accessory Image
---------------------------	-----------------

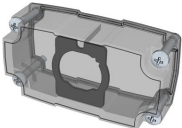
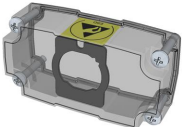

Blue bandpass filter (DM150-BP470)	
Red bandpass filter (DM150-BP635)	

Lens Covers

Accessory Name and Number	Accessory Image
Clear lens cover (DM150-CVR-CLR)*	
Clear lens cover, ESD safe (DM150-CVR-ESD)*	
Polarized front cover (DM260-LENS-62CVR-F)*	
Extended lens cover, un-polarized (DM260-LENS-16CVR)**	
Extended lens cover, half-polarized (DM260-LENS-16CVR-P)**	
Extended lens cover, fully polarized (DM260-LENS-16CVR-F)**	



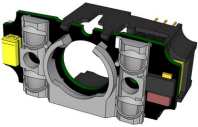

Note: *Use with a 6.2 mm lens only!
 **Use with a 16 mm lens only! For maximum light power 24VDC supply is recommended.

Light Options

Accessory Name and Number	Accessory Image
Red LED illumination (DM150-LED-RED)* Risk Group Exempt acc. IEC62471	
White LED illumination (DM150-LED-WHT) * Risk Group Exempt acc. IEC62471	
Blue LED illumination (DM150-LED-BLU)* Risk Group Exempt acc. IEC62471	
High Powered red LED illumination (DM260-LED-RED-HP)** Risk Group Exempt acc. IEC62471	

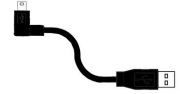
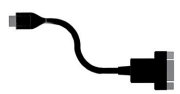
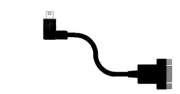
Note: *Use with a 6.2 mm lens only!
 **Use with a 16 mm lens only!

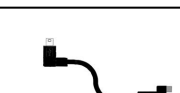
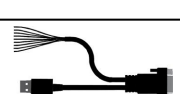
Cables





Accessory Name and Number	Accessory Image
Sealed USB type C cable to USB type A straight 2.5m (DMA-STCBLE-IP65-25)	
Sealed USB type C cable to USB type A straight 3.6m (DMA-STCBLE-IP65-36)	
Sealed USB type C cable to USB type A angled 2.5 m (DMA-RTCBLE-IP65-25)	
Sealed USB type C cable to USB type A angled 3.6m (DMA-RTCBLE-IP65-36)	
Sealed Serial I/O Adapter cable with straight USB type C connector (DMA-SERIAL-IP65-ST)	
Sealed Serial I/O Adapter cable with angled USB type C connector (DMA-SERIAL-IP65-RA)	
Industrial Ethernet connection module (DMA-EZCCM-001)	
EZCCM to USB cable (DMCB-EZCCM-USB-03)	
USB & Flying Leads I/O Cable, 2.0 m (DM-USBIO-00)	
RS-232 & Flying Leads I/O Cable, 2.5 m (DM-RS232IO-00)	

Power Supplies

Accessory Name and Number	Accessory Image
Power supply, 6V (DM100-PWR-000)	

Mounting Brackets

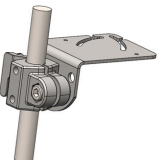
Accessory Name	Accessory Number	Accessory Image
----------------	------------------	-----------------

Mounting bracket	(DM100-UBRK-000)	
Pivot mounting bracket	(DM100-PIVOTM-01)	
Logistics Bracket	DMA-BKT-LGS	
Value Line Bracket	DMA-BKT-70-VAL	

IO Modules

Accessory Name and Number	Accessory Image
DataMan Basic I/O Module (DM100-IOBOX-000)	

DataMan 70 Systems

	1-D and Stacked Codes	Omni-directional 1-D Code Reading	1DMax™ — Best-In-Class 1-D Reading	Resolution
DataMan 70 S	√	√	√	752 x 480 Global shutter
DataMan 70 L	√		√	752 x 480 Global shutter
DataMan 70 QL	√	√	√	752 x 480 Global shutter
DataMan 70 Q	√	√	√	752 x 480 Global shutter
DataMan 72 S	√	√	√	1280 x 960 Global shutter
DataMan 72 L	√		√	1280 x 960 Global shutter
DataMan 72 QL	√	√	√	1280 x 960 Global shutter
DataMan 72 Q	√	√	√	1280 x 960 Global shutter

Model Variants

S models do not have Burst and Continuous trigger modes.

	70S	70L	70QL	70Q
2-D Codes	Yes	No	No	Yes
Algorithm	1DMax, HotBars	1DMax, IDQuick, HotBars	1DMax, IDQuick, HotBars	1DMax, IDQuick, HotBars
Acquisition	2 fps	60 fps		
Max Decode Rate	2/sec	45/sec	45/sec	45/sec

	72S	72L	72QL	72Q
2-D Codes	Yes	No	No	Yes
Algorithm	1DMax, Hotbars	1DMax, IDQuick, HotBars	1DMax, IDQuick, HotBars	1DMax, IDQuick, HotBars
Acquisition	2 fps	60 fps		
Max Decode Rate	2/sec	45/sec	45/sec	45/sec

Communication Module

The DataMan 70 is available with the following communication options:

- USB

15 pin Adapter Cable

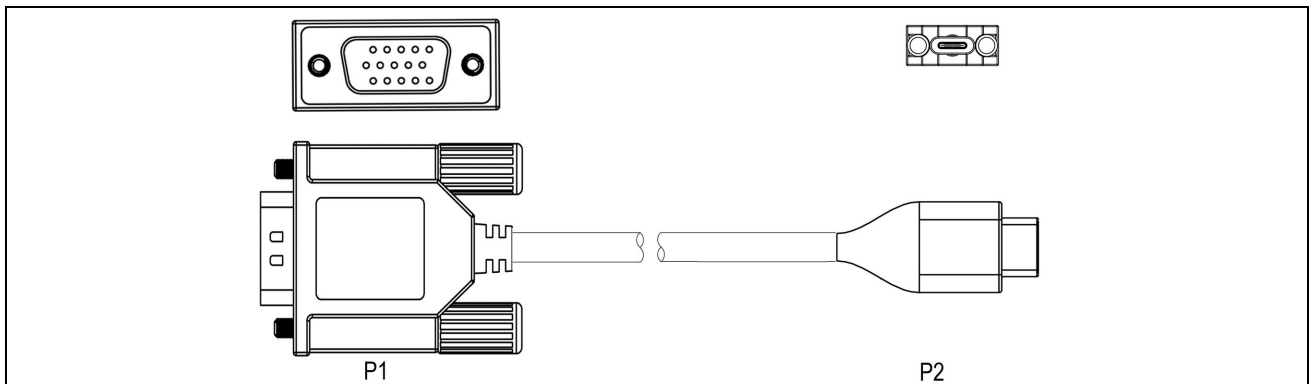

P1 Pin Number	Signal Name
1	Reserved
2	Reserved
3	Reserved
4	Reserved
5	Reserved
6	Ground
7	TXD
8	RXD

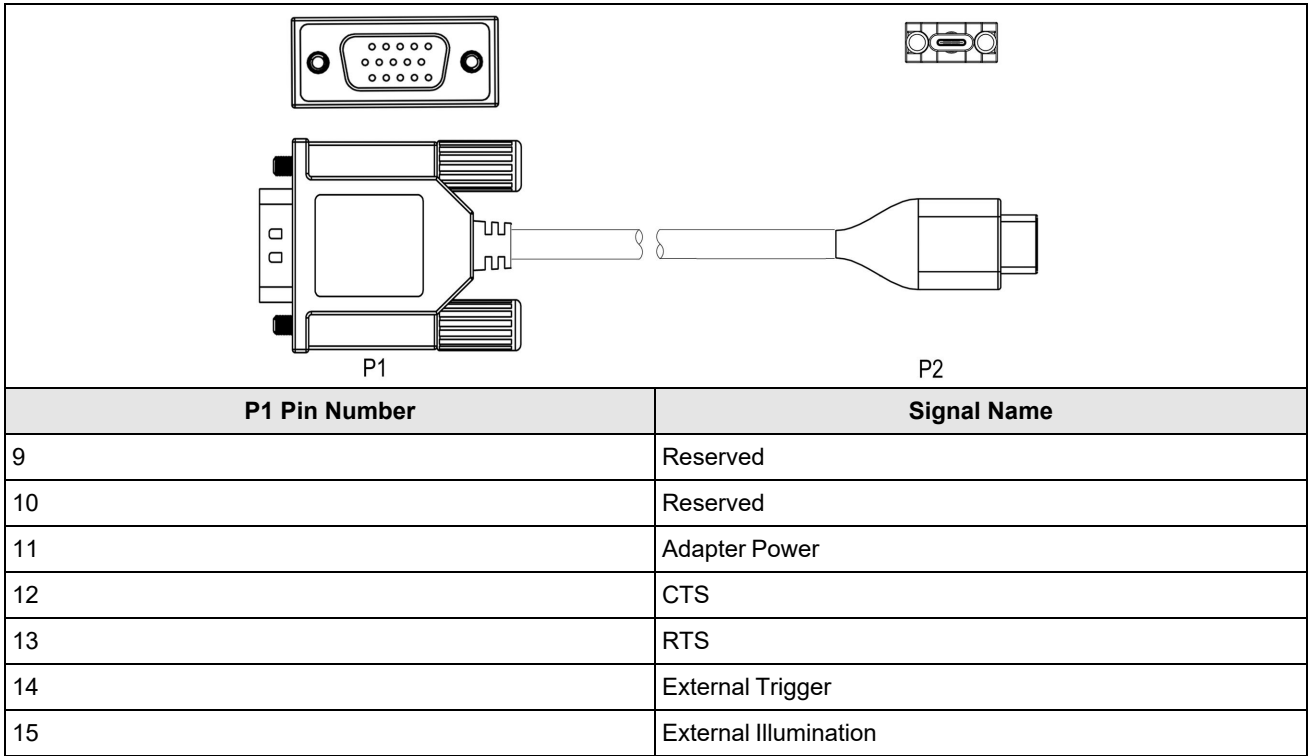

9 Pin Adapter Cable

The following table shows the pinouts.

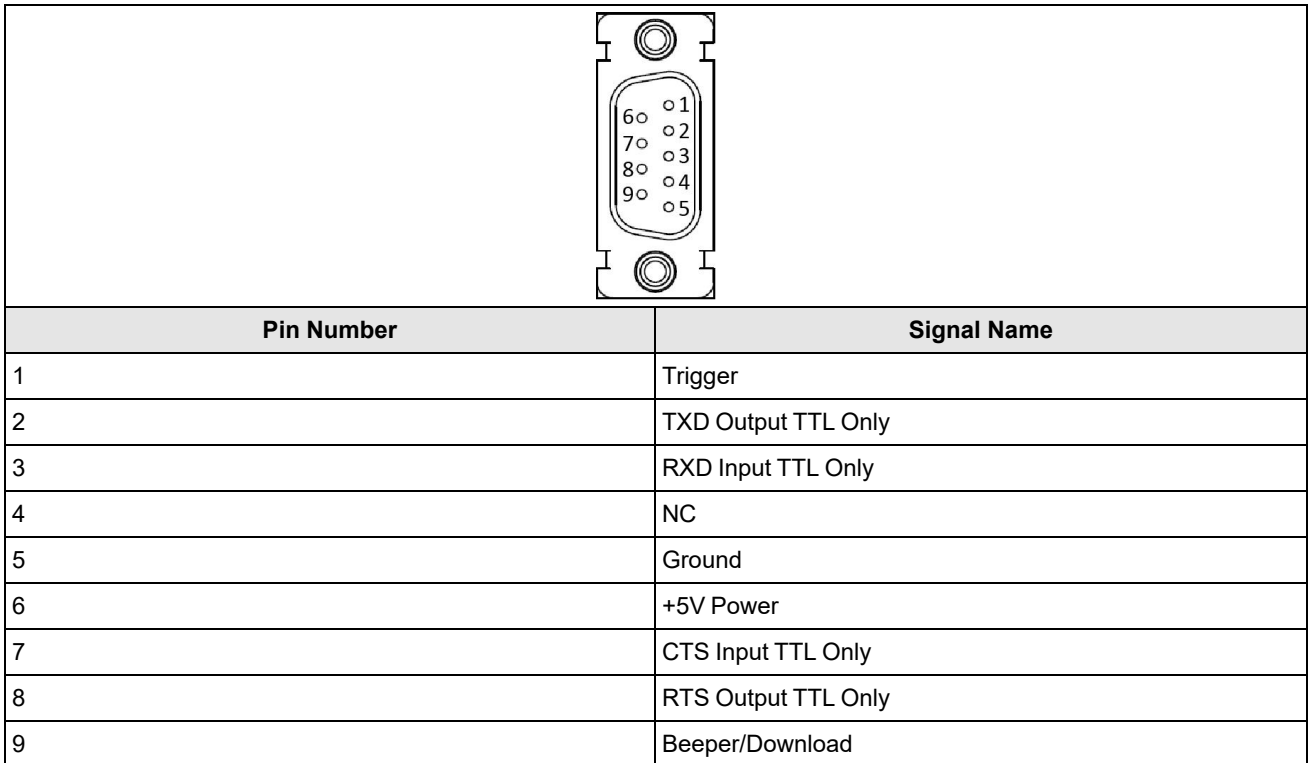

Serial I/O Adapter (DMA-SERIALREST-ST)

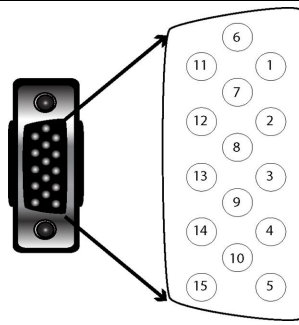

This is a male connector/plug.

Pin Number	Signal Name
1	Reserved
2	TxD
3	RxD
4	GND
5	DC+ (system power, 5-24 VDC)
6	NC
7	Output-0
8	Input-0
9	NC
10	NC
11	NC
12	Output-Common
13	NC
14	Reserved
15	Reserved

USB Connections

When connected to a PC over USB, the DataMan 70 appears as a COM port.

You can connect your device to the computer in the following ways:

Connect directly to the PC:

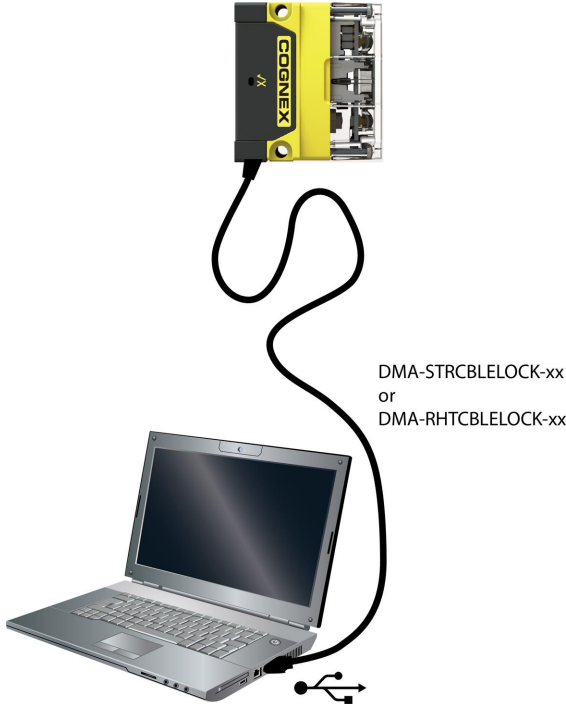

Connect to the PC through a basic I/O module:

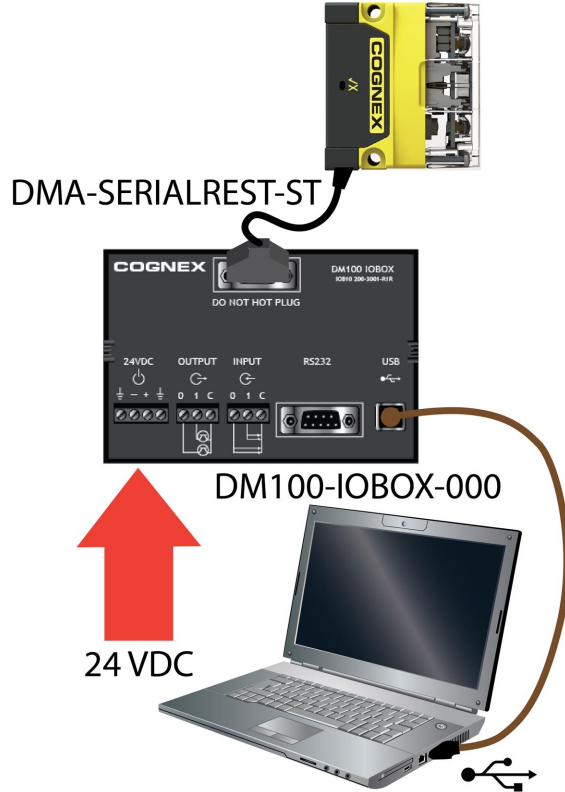

If the reader is configured as an HID device and you want to return to USB serial, scan the USB serial connection code:



Note: The DataMan PC software must be installed for this connection type!

Connecting to EZCCM

To connect the DataMan 70 reader to the industrial Ethernet connection module (EZCCM), the following cable is required: DMCB-EZCCM-USB-03.



Reader Layout

The following images show the built-in lighting system and other features of the DataMan 70.

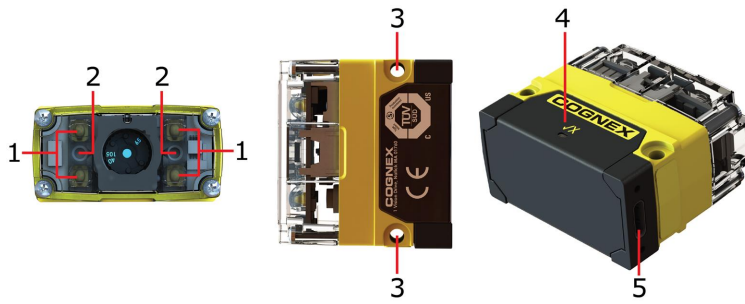







Item	Description
1	Illumination LEDs
2	LED aimers
3	Mounting holes
4	Good/bad read indicator
5	USB type-C port

Indicator LED

Type	Color	Meaning
Status LED spot	GREEN	Good read
	RED	Bad read

Illumination Options

Illumination Board	5V USB Powered		24V Externally Powered	
	Max. exposure time	Max. duty cycle	Max. exposure time	Max. duty cycle
Standard Red 	500 μ s	3%	1 ms	6%
High Power Red 	500 μ s	2%	10 ms	10%
Standard White 	450 μ s	3%	1 ms	6%
Standard Blue 	500 μ s	3%	1 ms	6%

Illumination Board	5V USB Powered		24V Externally Powered	
	Max. exposure time	Max. duty cycle	Max. exposure time	Max. duty cycle
IR 	500 μ s	3%	1 ms	6%
High Power IR 	500 μ s	3%	1 ms	6%

Dimensional Drawings

Observe the following reader dimensions when installing the DataMan 70 and DataMan 72 reader.

Note:



- Dimensions are in millimeters [inches] and are for reference purposes only.
- All specifications are for reference purposes only and can change without notice.

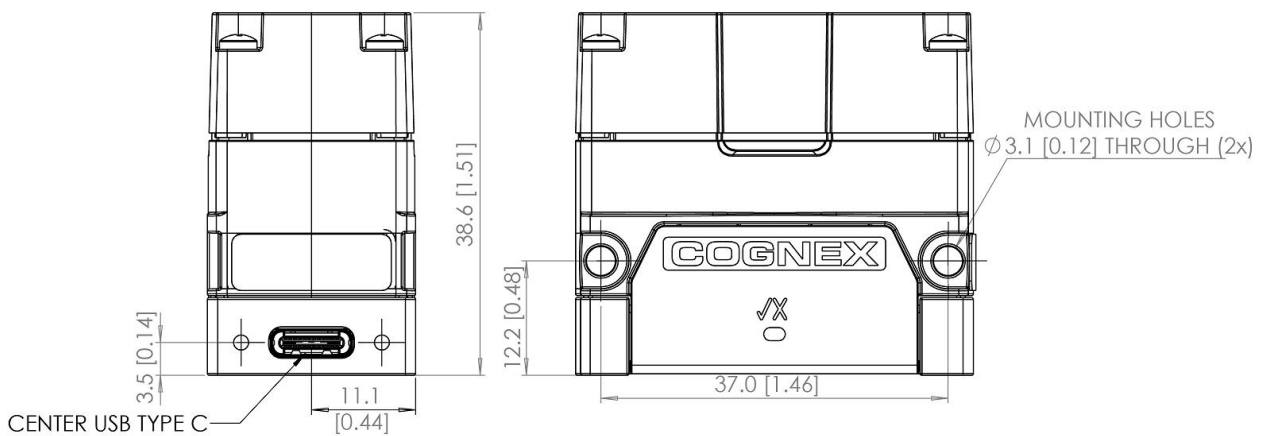
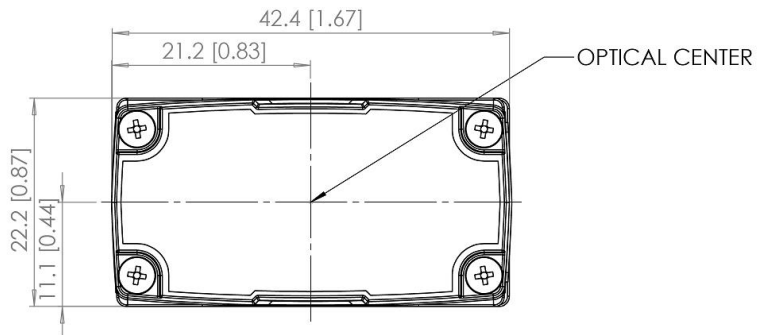

Setting Up Your DataMan 70

This section provides information on the physical appearance of the DataMan 70 reader, details the steps of mounting the reader, and gives information on the imager itself.

Mounting

Mounting the DataMan 70 at a slight angle (15°) can reduce reflections and improve reader performance. Having a recess for screw heads on the top and the bottom, DataMan 70 allows for upside down mounting. Recommended fasteners and nuts:

- Fastener: 2 x DIN 7985 M3x30mm or DIN 912/ISO 4762 M3x30mm
- Nut: 2 x DIN 985 M3

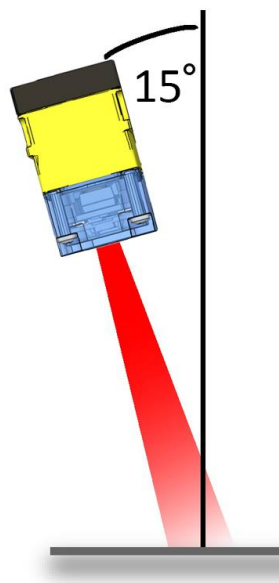
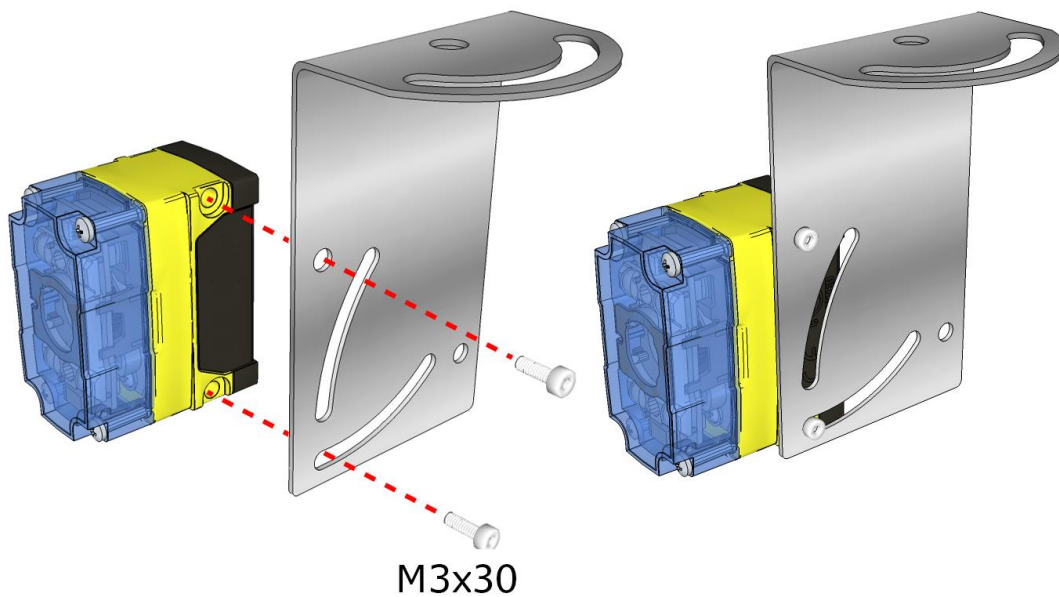

Field of View and Reading Distances

DataMan 70 Readers with a 6.2 mm Lens

Short Range (Focused to 105 mm)

The following map shows the FoV of the DataMan 70 series readers with a 6.2 mm lens. Outer FoV values refer to DM72, inner FoV values refer to DM70.

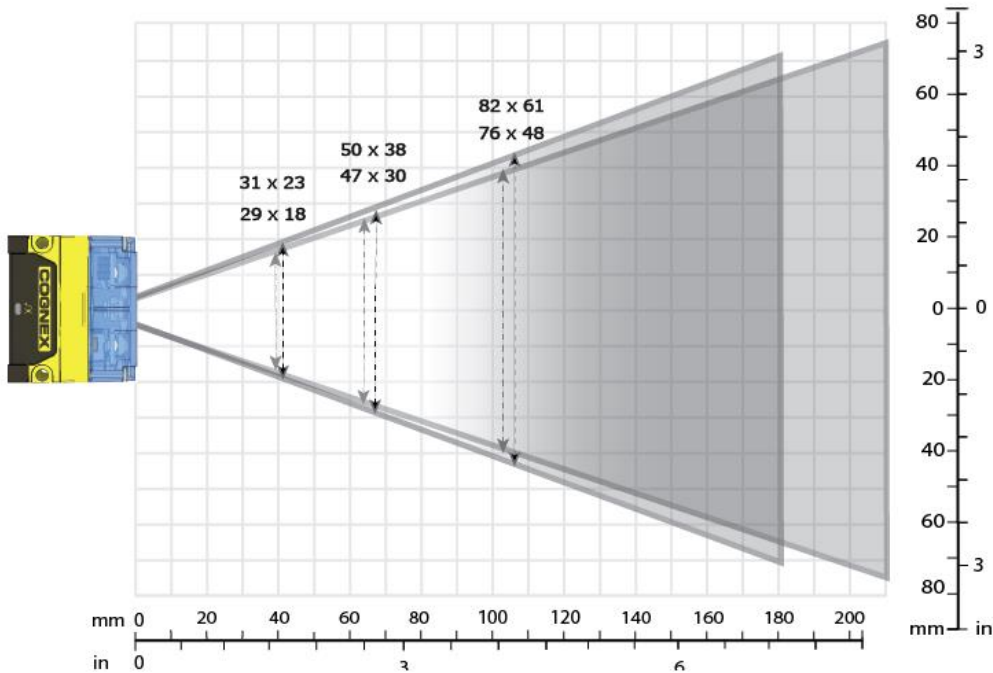

The following tables show the Field of View (FoV) widths of the 6.2 mm lens focused to 105 mm at various distances.

Device	Distances in mm	2D min. code	1D min. code
DM70	40	4 MIL	2 MIL
	65	5 MIL	3 MIL
	105	10 MIL	6 MIL
Device	Distances in mm	2D min. code	1D min. code
DM72	40	3 MIL	2 MIL
	65	4 MIL	2 MIL
	105	7 MIL	5 MIL

Long Range (Focused to 190 mm)

The following map shows the FoV of the DataMan 70 series readers with a 6.2 mm lens. Outer FoV values refer to DM72, inner FoV values refer to DM70.

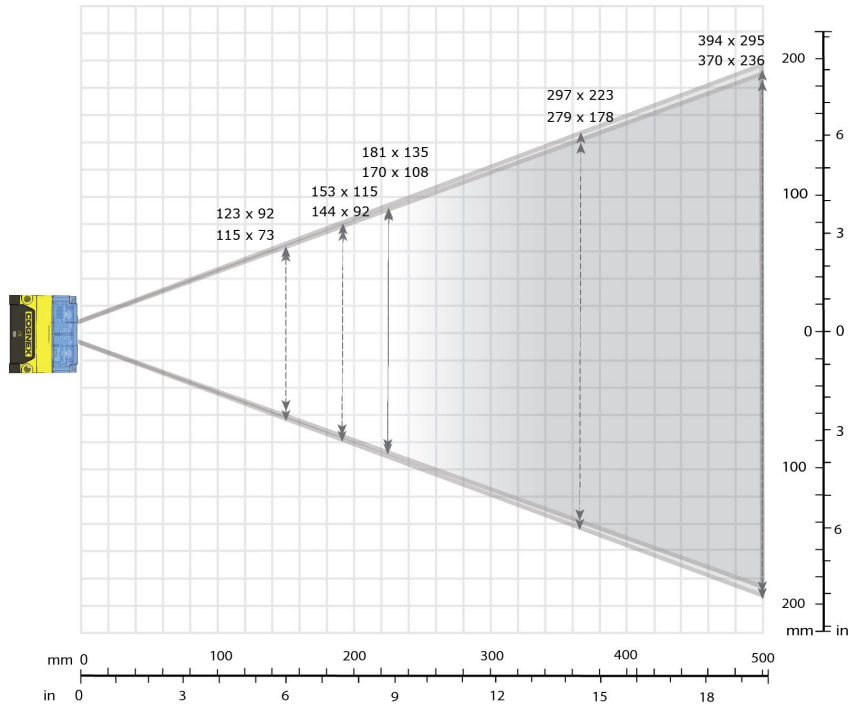

The following tables show the FoV widths of the 6.2 mm lens focused to 190 mm at various distances.

Device	Distances in mm	2D min. code	1D min. code
DM70	150	12 MIL	6 MIL
	190	15 MIL	10 MIL
	225	18 MIL	10 MIL
	375	30 MIL	15 MIL
	500	35 MIL	20 MIL
	1000	-	35 MIL
Device	Distances in mm	2D min. code	1D min. code
DM72	150	10 MIL	5 MIL
	190	12 MIL	6 MIL
	225	15 MIL	6 MIL
	375	20 MIL	10 MIL
	500	25 MIL	15 MIL
	1000	-	30 MIL

DataMan 70 Readers with a 16 mm Lens

The following map shows the FoV of the DataMan 70 readers with a 16 mm lens. Outer FoV values refer to DM72, inner FoV values refer to DM70 .

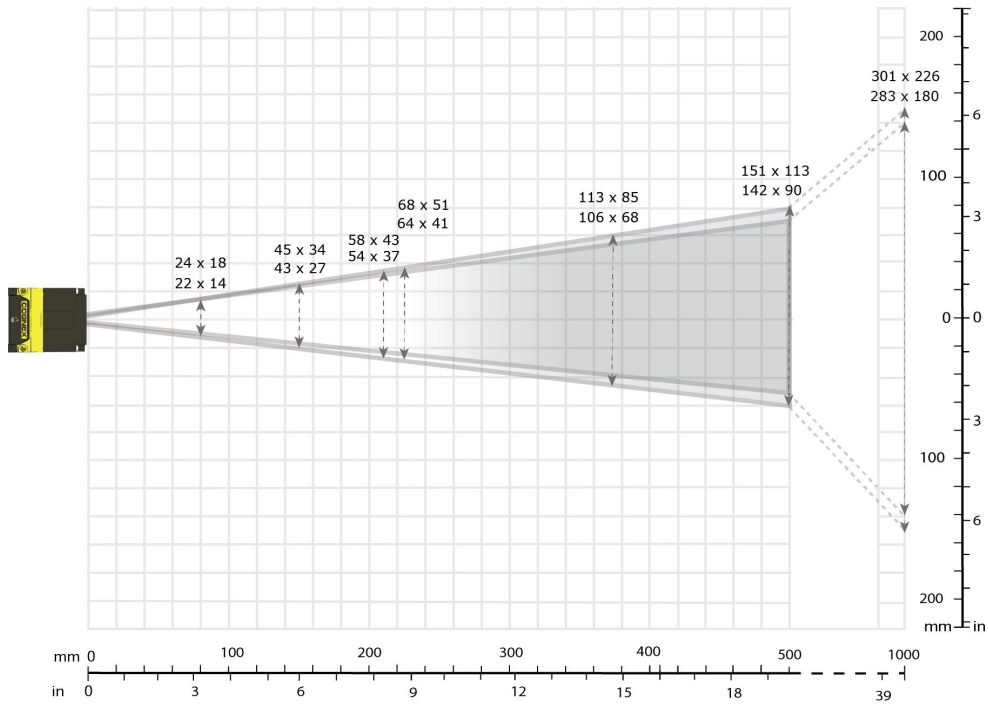

The following tables show the FoV widths of the 16 mm lens at various distances.

Device	Distances in mm	2D min. code	1D min. code
DM70	80	3 MIL	2 MIL
	150	5 MIL	3 MIL
	190	6 MIL	4 MIL
	225	7 MIL	4 MIL
	375	12 MIL	5 MIL
	500	15 MIL	10 MIL
	1000	25 MIL	15 MIL
Device	Distances in mm	2D min. code	1D min. code
DM72	80	2 MIL	2 MIL
	150	3 MIL	2 MIL
	190	4 MIL	2 MIL
	225	4 MIL	3 MIL
	375	7 MIL	4 MIL
	500	10 MIL	6 MIL
	1000	20 MIL	15 MIL

Connections, Optics and Lighting

I/O Cable

You can connect a cable with USB & flying leads (DM-USBIO-00) to the cable that is attached to the device. The following table shows the pinout and color description of the flying leads.

Note: GND (Pin 4) is connected to the reader housing, cable shield, and DB15 shell.

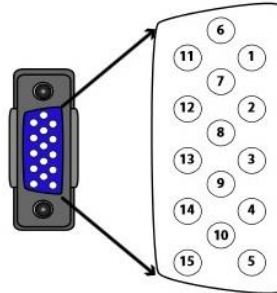

This is a female socket/connector.

PIN	Color	Signal
4	Black	GND
7	Blue/White	Output-0
8	White	Input-0
12	Light Blue/Yellow	Output-Common
13	Light Blue/Green	Input-Common

RS-232 Cable

You can connect a cable with RS-232 & flying leads (DM-RS232IO-00) to the cable that is attached to the device. The following table shows the pinout and color description of the flying leads.

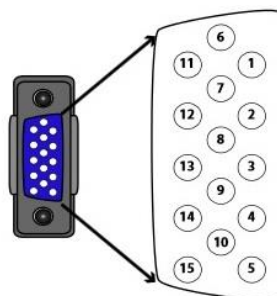

This is a female socket/connector.

PIN	Color	Signal
4	Black	GND
5	Brown/White	VDC
7	Blue/White	Output-0
8	White	Input-0

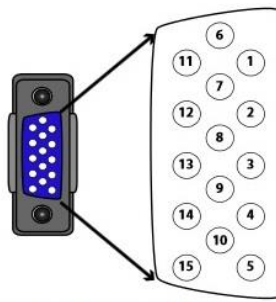

This is a female socket/connector.

PIN	Color	Signal
12	Light Blue/Yellow	Output-Common
13	Light Blue/Green	Input-Common

DataMan 70 Series Specifications

Specification	DataMan 70 Series Reader
Weight	43 g (without cable)
Operating Temperature	0°C — +40°C (+32°F — +104°F) ¹
Storage Temperature	-10°C — +60°C (+14°F — +140°F)
Maximum Humidity	<95% (non-condensing)
Environmental	IP65
Shock and Vibration	IEC 60068-2-27: 1000 shocks, semi-sinusoidal, 11g, 10ms IEC 60068-2-6: vibration test in each of the three main axis for 2 hours @ 10 Gs (10 to 500 Hz at 100m/s ² / 15mm)
LED Safety	IEC 62471: Exempt risk group, no further labeling is required.
Codes	1-D barcodes: Codabar, Code 39, Code 128, and Code 93, Code 25, Interleaved 2 of 5, Pharma, Code UPC/EAN/JAN, MSI 2-D barcodes: Data Matrix™ (I IDQuick: ECC 0, 50, 80, 100, 140, and 200) QR Code and microQR Code, PDF 417, MicroPDF 417, AztecCode, MaxiCode
Power Supply Requirements	<ul style="list-style-type: none"> • USB powered: 2.5 W, or • External power supply: +5 — +24 VDC Supplied by limited-energy circuit according to IEC/ UL/ CSA 61010-1
Power Consumption	5VDC, <2.5 W (powered over USB), average power max. 1.5 W

¹ Housing temperature must not exceed +60°C (+140°F). Mounting the reader onto a metal bracket is recommended for temperatures above +32°C (+90°F).

DataMan 70 Series Imager Specifications

Specification	DataMan 70 Imager	DataMan 72 Imager
Image Sensor	1/3 inch CMOS	1/3 inch CMOS
Image Sensor Properties	4.51 mm x 2.88 mm (W x H), 6.0 μm square pixels	4.86 mm x 3.66 mm (W x H), 3.75 μm square pixels
Image Resolution (pixels)	752 x 480	1280 x 960
Lens Type	S-mount 6.2 mm F:7 S-mount 16 mm F:7	

LED Wavelengths

The following table shows LED types and the related wavelengths:

LED	λ [nm]
RED	617
RED HPIL	617

Using Your DataMan 70

This section provides general information about the installation process of the DataMan Setup Tool, triggering, and reader training.

Installing the DataMan Software

Perform the following steps to install the DataMan Setup Tool:

1. Check the **DataMan Release Notes** for a full list of system requirements.
2. Download the DataMan Setup Tool from <http://www.cognex.com/support/dataman> and follow the on-screen steps.
3. Connect the DataMan 70 to your PC.
4. Choose **Start > Programs > Cognex > DataMan Software vx.x.x > Setup Tool** to launch the DataMan Setup Tool. Detected readers will appear under **COM ports**.
5. Click **Refresh** to update the list of connected devices.
6. Select the device from the Network list (**Discovered Devices**) and click **Connect**.

Setting the Focus Position

DataMan 70 can operate in one of three distance ranges. Follow the steps below to set the focus position.

1. Remove the screws and the front cover.

DM70 with 6.2 mm lens

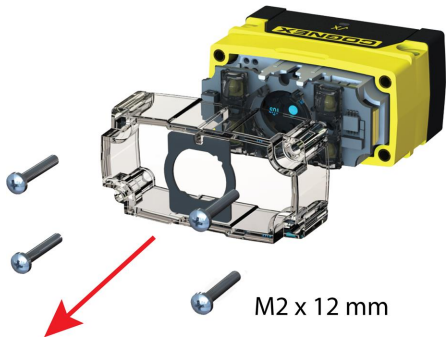

DM70 with 16 mm lens

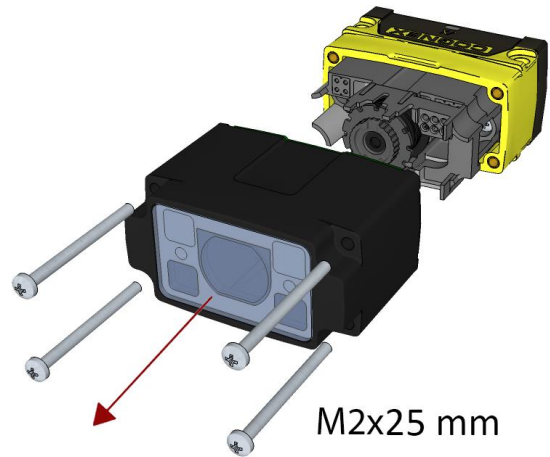

2. Using a flathead screwdriver, set the focus position from the front. Always turn clockwise to focus to a larger distance and counterclockwise to focus to a shorter distance.

DM70 with 6.2 mm lens

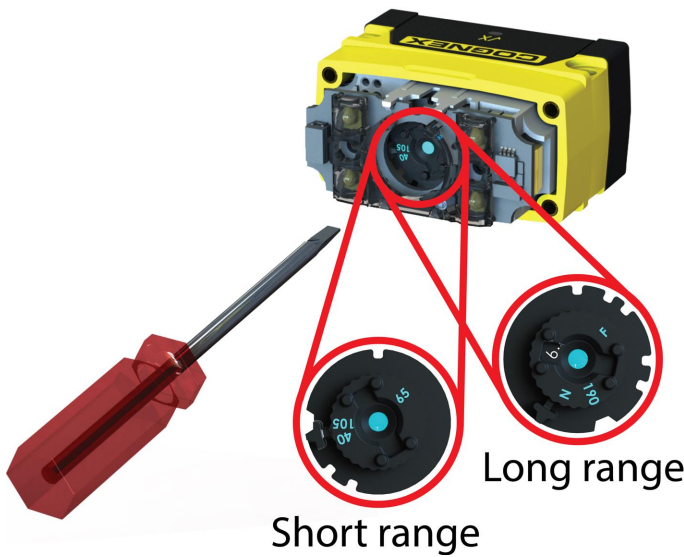

DM70 with 16 mm lens



3. Remount the front cover. Observing the tightening sequence below, tighten all four screws to 9 Ncm using a torque wrench.

DM70 with 6.2 mm lens

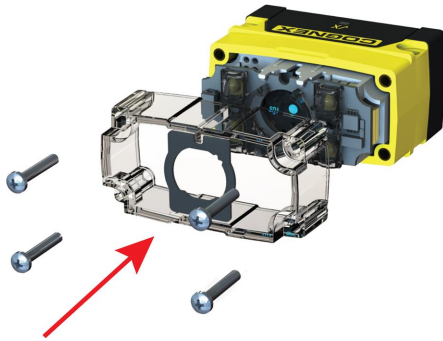

DM70 with 16 mm lens

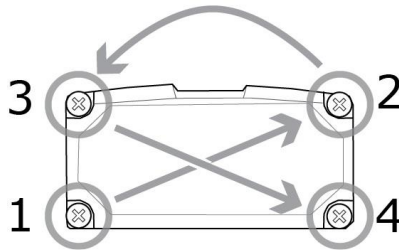
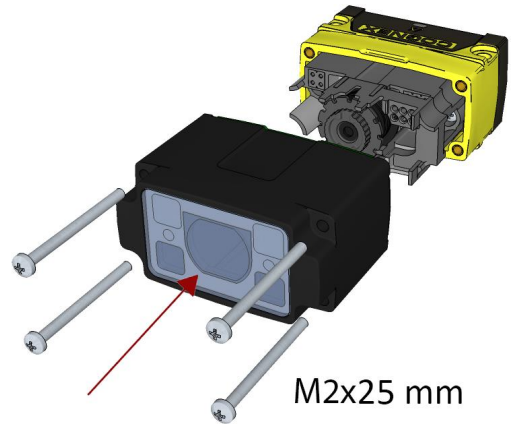

Note: The rib in the front cover must be oriented to the top side.

Trigger Modes

DataMan 70 supports a variety of trigger modes:

- **Single:** Acquires a single image and attempts to decode any symbol it contains or more than one symbol in cases where multicode is enabled. The reader relies on an external trigger source.
- **Presentation:** Repeatedly scans for a symbol and decodes it whenever one is detected. The reader relies on an internal timing mechanism to acquire images.
- **Burst:** Performs multiple image acquisitions based on an external trigger and decodes one or multiple symbols appearing in the sequence of images.
- **Self:** Similar to *Presentation* mode in that the reader perpetually scans for symbols and decodes them each time one is detected. Unlike *Presentation* mode, however, *Self* mode supports multicode results and a decode attempt occurs with every image. The main difference between *Self* and *Presentation* is the fixed and exact interval for image acquisitions in *Self*.
- **Continuous:** Begins acquiring images based on a single external trigger and continues to acquire images until a symbol is found and decoded, or until multiple images containing as many codes as specified in multicode mode are located, or until the trigger is released.

Training and Trigger Modes

Training is supported for the following trigger modes:

- Single trigger
- Burst mode
- Self trigger
- Continuous mode

Training

Training your reader with the expected symbology may help increase decode yield. To train your reader, place a code in front of the reader and do one of the following:

- Click and hold the trigger button in the DataMan Setup Tool () for at least 3 seconds and then release it.
- Click **Train Code** in the **Action** ribbon of the DataMan Setup Tool.

If using Single trigger mode, upload the code through **File** -> **Train Image**.

i **Note:** You can use training in *Single*, *Burst*, *Continuous* or *Self* trigger modes. Only a single symbol of each kind of symbology can be trained per read setup.

Wiring the Basic I/O Module

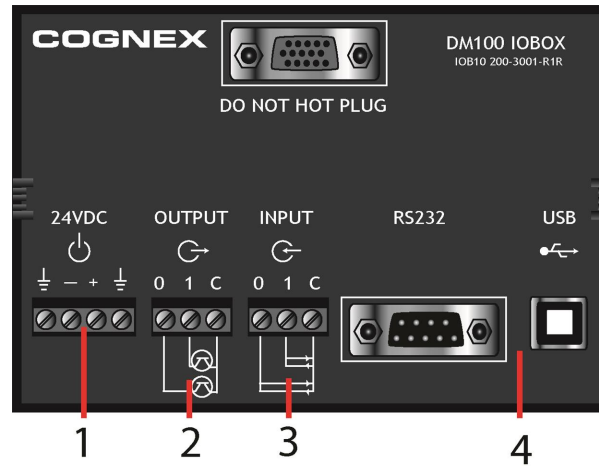

1. **Power:** 5-24 VDC, 2.5W peak.
2. **Discrete output:** Only Output 0 is supported, current sink or source depending on wiring of output common (C). Max current is 25 mA.
3. **Trigger input:** Only Input 0 is supported, current sink (2mA), has reference to DC-, 30V max., Input 0 is dedicated trigger line.
4. **Communication ports:** RS-232 serial port and USB.

Note: You must use a null modem cable when connecting the Basic I/O Module to a PC's RS-232 serial port.

Output Wiring Example

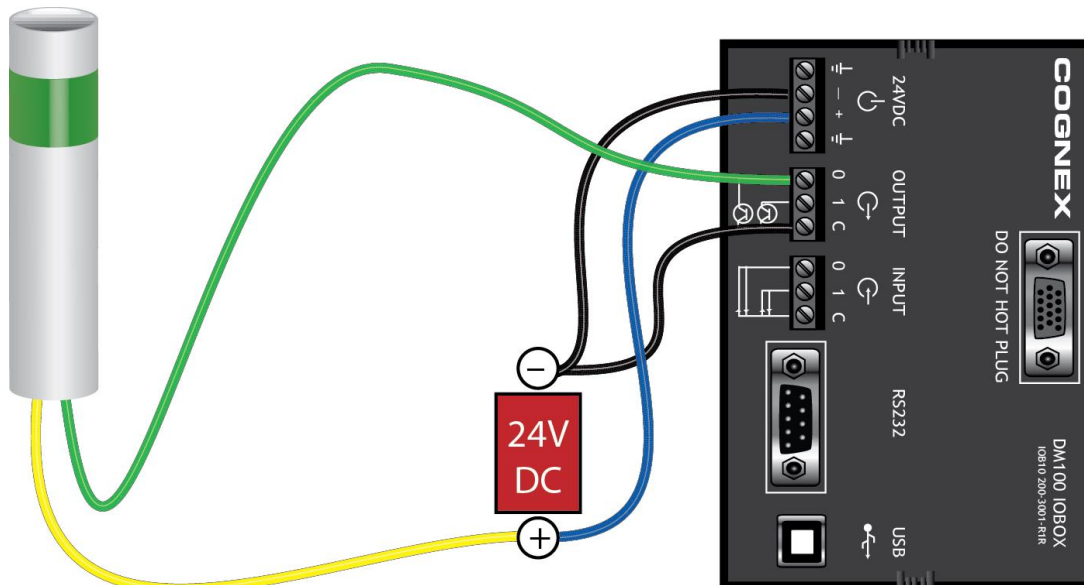

Input Wiring Example

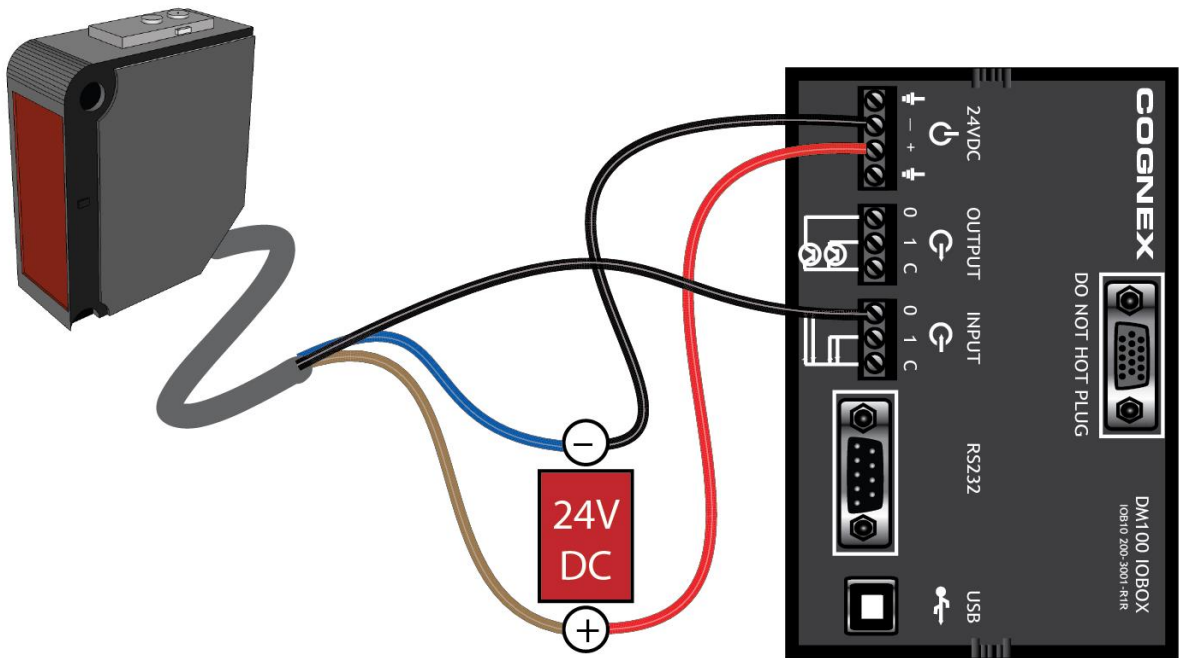

Multi-port Connections

You can connect multiple DataMan 70 readers to a single PC (or other device equipped with a serial port) using a multi-port connection.

A multi-port connection creates a daisy-chain of readers. Each reader receives serial data from the previous reader and transmits it to the next reader. When a reader transmits data, it is passed through each of the readers in the chain between it and the PC.

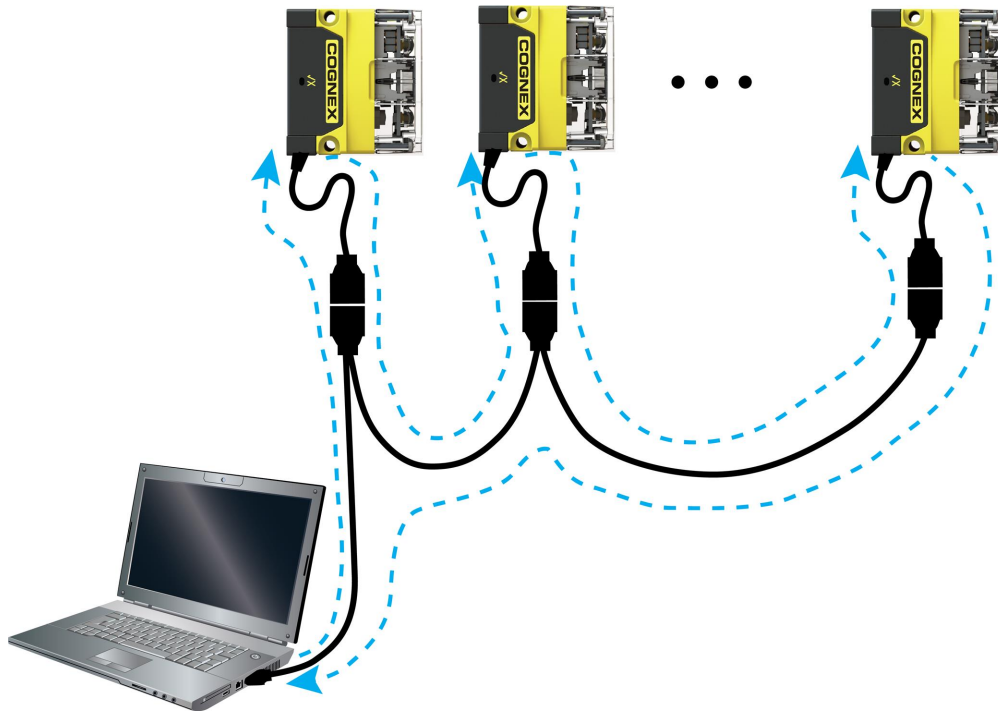

You must construct your own cable that meets the requirements of your system configuration.

The cable must provide a DB-15 connector for each DataMan 70 and a DB-9 connector for the PC serial port. Each DB-15 connector must provide Tx Data, Rx Data, Trigger (Input 0), ground, and DC power. The Tx Data and Rx Data pins on adjacent connectors must be connected to provide the multi-port connection.

The following diagram shows how to create a multi-port cable for a 3-reader system. In the example, all the readers share a common trigger. It is also possible to wire individual triggers for each reader.

You must connect each DataMan 70 to DataMan Setup Tool using a USB connection and set the DataMan for multi-port operation. To configure a DataMan 70 for multi-port operation, click on the **Enable Multi-Port (RS-232 Sharing)** check box in **Communication Settings**.

There is no guaranteed delivery order when multiple readers transmit data using a multi-port connection; read results may arrive at the PC in any order. You can configure each DataMan 70 reader in a multi-port connection to add identifying data to each read result. Your PC application can then determine which reader produced a specific read result.

To do this, check the **Standard Formatting Enabled** box (for each symbology that you are using) in **Data Formatting**, and enter text in the **Leading Text** field. (You can also add trailing text by entering text in the **Trailing Text** field.)

You can obtain the best results when using multi-port connections by keeping the following usage guidelines in mind as you design your system:

- The maximum cable length between any two DataMan 70 readers or between the PC and any DataMan reader should be no greater than 15 meters.

- There is no fixed limit to the number of DataMan 70 readers that you can connect to a single PC. Each reader introduces a delay of about 100 ms when it retransmits received serial data. If you have 5 readers, this means that there will be a 400 ms delay between the time the first reader in the chain transmits data and the PC receives it.
- Each DataMan 70 reader must receive a hardware trigger signal on its Input 0 line. You can wire the input ports to a common trigger signal or you can provide individual triggers for each reader.
- Each DataMan 70 reader must be individually configured for multi-port operation, and you must perform this configuration using a USB connection.
- If *any* reader in the multi-port chain loses power or becomes disconnected, then no data from any other reader will be transmitted.
- If a DataMan 70 is transmitting its own read result, it will buffer any data received from another reader until it has finished its own data transmission. If a DataMan 70 is transmitting another reader's data, it will buffer its own data if it receives a trigger signal while it is processing the other reader's data.
- If you use a single power supply for multiple readers, make sure that the power supply can provide enough power for all of the readers.

Cleaning and Maintenance

Cleaning the Reader Housing

To clean the outside of the reader housing, use a small amount of mild detergent cleaner or isopropyl alcohol on a cleaning cloth. Do not pour the cleaner directly onto the reader housing.



CAUTION: Do not attempt to clean any DataMan product with harsh or corrosive solvents, including lye, methyl ethyl ketone (MEK) or gasoline.

Cleaning the Reader Lens Cover

To remove dust from the lens cover, use a pressurized air duster. The air must be free of oil, moisture or other contaminants that could remain on the lens cover. To clean the plastic window of the lens cover, use a small amount of isopropyl alcohol on a cleaning cloth. Do not scratch the plastic window. Do not pour the alcohol directly on the plastic window.

Precautions

To reduce the risk of injury or equipment damage, observe the following precautions when you install the Cognex product:

- Route cables and wires away from high-current wiring or high-voltage power sources to reduce the risk of damage or malfunction from the following causes: over-voltage, line noise, electrostatic discharge (ESD), power surges, or other irregularities in the power supply.
- Changes or modifications not expressly approved by the party responsible for regulatory compliance could void the user's authority to operate the equipment.
- Ensure that the cable bend radius begins at least six inches from the connector. Cable shielding can be degraded or cables can be damaged or wear out faster if a service loop or bend radius is tighter than 10X the cable diameter.
- This device should be used in accordance with the instructions in this manual.
- All specifications are for reference purposes only and can change without notice.
- This product is intended for industrial use in automated manufacturing or similar applications.
- The safety of any system incorporating this product is the responsibility of the assembler of the system.
- This product does not contain user-serviceable parts. Do not make electrical or mechanical modifications to product components. Unauthorized modifications can void your warranty.

Regulations/Conformity

The DataMan 70 has Regulatory Model R00044 and meets or exceeds the requirements of all applicable standards organizations for safe operation. However, as with any electrical equipment, the best way to ensure safe operation is to operate them according to the agency guidelines that follow. Please read these guidelines carefully before using your device.

Note: For the most current CE and UKCA declaration and regulatory conformity information, see the Cognex support site: cognex.com/support.

Safety and Regulatory	
Manufacturer	Cognex Corporation One Vision Drive Natick, MA 01760 USA
USA	FCC 47 CFR Part 15 Subpart B, Class A This device complies with Part 15 of the FCC Rules. Operation is subject to the following two conditions: (1) this device may not cause harmful interference; and (2) this device must accept any interference received, including interference that may cause undesired operation. This equipment generates, uses, and can radiate radio frequency energy and, if not installed and used in accordance with the instruction manual, may cause harmful interference to radio communications. Operation of this equipment in a residential area is likely to cause harmful interference in which case the user will be required to correct the interference at their own expense.
Canada	ICES 003 compliant CAN ICES-3 (A)/NMB-3(A) This Class A digital apparatus complies with Canadian ICES-003. Cet appareil numérique de la classe A est conforme à la norme NMB-003 du Canada.
Europe	EN 61326-1, Class A IEC 61010-1 UL 61010-1:2012/R:2015-07, CAN/CSA-C22.2 No. 61010-1:2012 + UPD No. 1:2015-07 + UPD No. 2:2016-04 This is a class A product. In a domestic environment this product may cause radio interference in which case the user may be required to take immediate measures. This equipment complies with the essential requirements of the EU Directive 2014/30/EU. Declarations are available from your local representative. The CE mark on the product indicates that the system has been tested to and conforms with the provisions noted within the 2014/30/EU Electromagnetic Compatibility Directive. For further information please contact: Cognex Corporation, One Vision Drive Natick, MA 01760 USA. Cognex Corporation shall not be liable for use of our product with equipment (i.e., power supplies, personal computers, etc.) that is not CE marked.
Australia	AS/NZS 3548, CISPR 22 Class A 
Korea	KN32, KN35 A급 기기(업무용 방송통신기자재): 이 기기는 업무용(A급) 전자파적합기기로서 판매자 또는 사용자는 이 점을 주의하시기 바라 며, 가정외의 지역에서 사용하는 것을 목적으로 합니다. Certificate number: MSIP-REM-CGX-DM70

Safety and Regulatory	
Japan	VCCI-3/2015.04 Class A <div style="border: 1px solid black; padding: 5px; text-align: center;"> <p>この装置は、クラスA情報技術装置です。この装置を家庭環境で使用すると電波妨害を引き起こすことがあります。この場合には使用者が適切な対策を講ずるよう要求されることがあります。 VCCI-A</p> </div>
TÜV	Regulatory Model 1AA3 Regulatory Model 1ABE
	TÜV SÜD SCC/NRTL OSHA Scheme for UL/CAN 61010-1..
	CB report available upon request. .TÜV SÜD, IEC/EN 61010-1.

LED Safety Statement

This device has been tested in accordance with IEC62471, and has been certified to be under the limits of Exempt Risk Group. No further labeling is required.

For European Community Users

Cognex complies with Directive 2012/19/EU OF THE EUROPEAN PARLIAMENT AND OF THE COUNCIL of 4 July 2012 on waste electrical and electronic equipment (WEEE).

This product has required the extraction and use of natural resources for its production. It may contain hazardous substances that could impact health and the environment, if not properly disposed.

In order to avoid the dissemination of those substances in our environment and to diminish the pressure on the natural resources, we encourage you to use the appropriate take-back systems for product disposal. Those systems will reuse or recycle most of the materials of the product you are disposing in a sound way.



The crossed out wheeled bin symbol informs you that the product should not be disposed of along with municipal waste and invites you to use the appropriate separate take-back systems for product disposal.

If you need more information on the collection, reuse, and recycling systems, please contact your local or regional waste administration.

You may also contact your supplier for more information on the environmental performance of this product.

Copyright © 2025
Cognex Corporation. All Rights Reserved.

