

For complete instructions,  
see <http://www.cognex.com/support/DS1000>

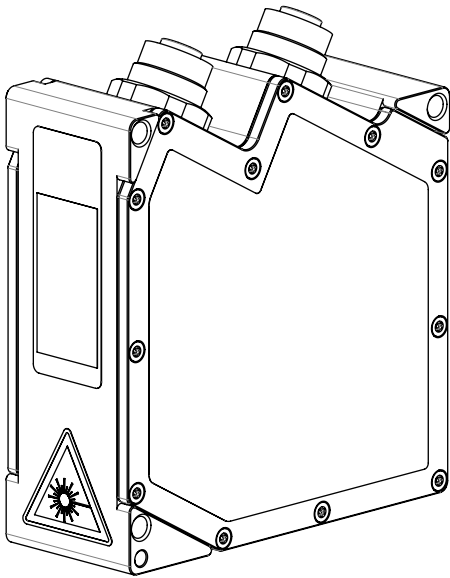

590-10005

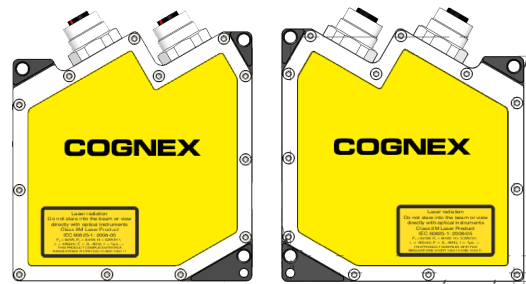

**Laser radiation**  
Do not stare into the beam or view  
directly with optical instruments  
Class 2M LaserProduct  
IEC 60825-1: 2008-05  
 $P_0 \leq 8\text{mW}$ ,  $P_p \leq 8\text{mW}$ ;  $H \leq 52\text{W/m}^2$ ;  
 $\lambda = 405\text{nm}$ ;  $F = 0...4\text{kHz}$ ;  $t = 1\mu\text{s}... \infty$

### Laser Safety Statement - DS925B



Compliance with FDA performance standards for laser products except for deviations pursuant to Laser Notice No. 50, dated June 24, 2007.

This device has been tested in accordance with IEC60825-1 2nd ed., and has been certified to be under the limits of a Class 2M Laser device.

Use of controls or adjustments or performance of procedures other than those specified herein may result in hazardous radiation exposure.

## Warnings and Notices

- Do not stare into the beam.
- Do not view directly with optical instruments (magnifiers).
- Do not place optical components (mirrors) into the beam.
- Design test fixtures in such a way that unintentional viewing of the beam is prevented.
- Switch off the laser when not in use.
- Avoid the use of highly reflective materials. If you cannot, try to angle the part so unintentional viewing of the reflection is prevented.
- Terminate (block) unused beams.
- Keep the laser plane horizontal or pointing downwards.
- Report any issues that may have an impact on laser safety to your supervisor or Laser Safety Officer.
- There is no scheduled maintenance necessary to keep the product in compliance.
- Under no circumstance should you modify in any way the sensor or its housing.
- Caution – Use of controls or adjustments or performance of procedures other than those specified herein may result in hazardous radiation exposure.
- When moving the unit from a very hot environment to a cold environment please allow the unit to equalize in a room temperature environment for 24 hours between temperature extremes.
- DS900 Series Sensors with a maximum laser power up to 8 mW are classified in Laser Class 2M (IIM).
- Hazard to the eye via laser radiation! Consciously close your eyes or turn away if the laser radiation impinges on the eye.
- Lasers of Class 2M are not subject to notification and a laser protection officer is not required. Mark the laser area recognizable and everlasting.

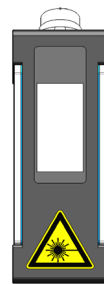

**LASER LIGHT, DO NOT STARE INTO BEAM: CLASS 2M LASER PRODUCT**

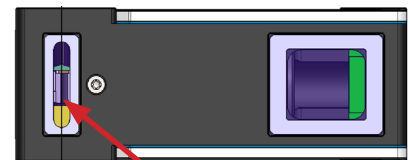

**AVOID EXPOSURE - LASER RADIATION IS EMITTED FROM THIS APERTURE**

## Ethernet Connector

The ethernet connection uses an M12-8 female connector.

RJ45 Connector		8-pin screw connector (sensor side)		
Pin No.	Color stranded hook-up wire	Pin no.	10BaseT, 100BaseTX	1000BaseT
1	white (orange)	5	Tx+	D1+
2	orange	6	Tx-	D1-
3	white (green)	8	Rx+	D2+
4	blue	1		D3+
5	white (blue)	2		D3-
6	green	7	Rx-	D2-
7	white (brown)	3		D4+
8	brown	4		D4-

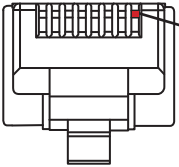

View on pin side male cable connector

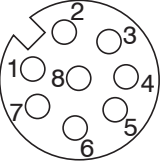

View on solder pin side screw connector

Cognex recommends the Gigabit-Ethernet connection cable CCB-2901858-05 for the Ethernet connection (5 m). Characteristics: 4 x 2 x 0.4 mm<sup>2</sup>; shielded.

**NOTE:** not compatible with the one used by DS1xxx Series.

The sensors are to be preferably connected directly to the network connection or to a high-quality switch. As a hub would result in a massive data collision it cannot be used. The PC should have one or more network cards dedicated only for the sensors.

Operating the sensor via Ethernet does not require any driver installation. However, the network settings have to be correct:

- If more than one network card is used, they must be placed on different subnets.
- Certain network settings will affect (and in some cases inhibit) the performance of the sensor (for example firewall and packet filter settings).
- A packet (payload) size of 1024 bytes/packet is recommended. The sensor is capable of supporting jumbo frames up to 4096 bytes/packet, provided all network components also support jumbo frames.
- The sensor supports DHCP (this setting is activated by default). If the sensor is unable to obtain a network address via DHCP, the sensor will use link-local addressing (169.254.x.x). Note that IP address conflict detection is not implemented.
- The sensor supports Power over Ethernet (PoE).
- The sensor can be configured with a fixed (static) IP address using the Cognex GigE Vision Configurator PC application.

## Multifunction Port

The multifunction cable provides access to trigger and inputs and Power Over Ethernet. The drawing on the left shows the **plug** on the device.

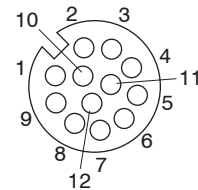
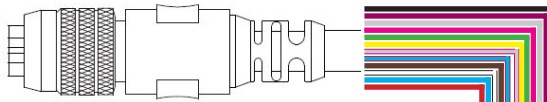
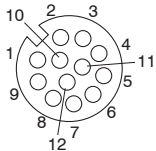

Pin #	Signal Name	Notes	Wire Color
9	PWR	+ 11 V - 30 V DC rated value 24 V); max. 500 mA	Red
2	GND	0 V	Blue
3	+Laser on/off	Optional	White
1	-Laser on/off		Brown
12	RS422	RS422, input respectively output	Red/Blue
11	/RS422		Gray/Pink
6	In1	Digital Input 1	Yellow
4	GND-In1	Ground In1	Green
5	In2	Digital Input 2	Pink
8	GND-In2	Ground In2	Gray
10	In3	Digital Input 3	Purple
7	GND-In3	Ground In3	Black

12-pin screw connector, view on solder pin side

- **PWR, GND:** galvanically isolated from IN1...3, RS422 and Laser on/off
- **Laser on/off:** Input galvanically isolated from GND, IN1...3, RS422
- **IN1, IN2, IN3, RS422:** Inputs galvanically isolated from GND and Laser on/off
- **GND-In1, GND-In2, GND-In3** - IO ground references for In1, IN2, In3 and RS422 IO's. Galvanically isolated from GND.

### RS422

The RS422 connection (Pin 11 and 12 of the multifunction port) can be used in either of the following configurations:

- Load user modes and sensor control (half-duplex RS422)
- Supplying line trigger signals
- Synchronization of line trigger signals

### Trigger, Encoder, Mode Switching

The switching inputs of the multifunction port can either be used for encoder input, for trigger input or for loading previously stored user modes.

The signal levels are switchable for all switching inputs between LLL (low-voltage-, TTL logic) and HLL (high-voltage-, HTL logic):

- LLL level: Low 0 V ... 0.8 V, high 2.4 V ... 5 V, internal pull-up 10 kΩ to 5 V
- HLL level: Low 0 V ... 3 V, high 11 V ... 24 V (permitted to 30 V), internal pull-up 10 kΩ to 24 V
- Pulse duration: ≥ 5 μs